



TECHNICAL MANUAL

INVERTER PACKAGED AIR-CONDITIONERS (Split system, air to air heat pump type)

AND

VRF INVERTER MULTI-SYSTEM AIR-CONDITIONERS

CEILING CASSETTE-4 WAY TYPE (FDT)

CEILING CASSETTE-4 WAY COMPACT TYPE (FDTC)

Technical Information of the New Model

Technical Information of the New Model (FDT , FDTC)

1. Change point

Indoor model	Accessories	New					Current					Changed contents
		Model name	Exterior appearance	Color		Inlet grill type	Model name	Exterior appearance	Color		Inlet grill type	
				Munsell	RAL				Munsell	RAL		
FDT	Panel (Standard)	T-PSA-5BW-E	Fine snow	8.0Y9.3 / 0.1 near equivalent	9001 near equivalent	Grid	T-PSA-5AW-E	Plaster white	6.8Y8.9/0.2 near equivalent	9003 near equivalent	Grid	Panel color
	Panel (Prevention)	T-PSAE-5BW-E	Fine snow	8.0Y9.3 / 0.1 near equivalent	9001 near equivalent	Grid	T-PSAE-5AW-E	Plaster white	6.8Y8.9/0.2 near equivalent	9003 near equivalent	Grid	Panel color
	Wireless kit	RCN-T-5BW-E2	Fine snow	8.0Y9.3 / 0.1 near equivalent	9001 near equivalent	—	RCN-T-5AW-E2	Plaster white	6.8Y8.9/0.2 near equivalent	9003 near equivalent	—	Panel color Latest software ※2
	Motion sensor kit	LB-T-5BW-E	Fine snow	8.0Y9.3 / 0.1 near equivalent	9001 near equivalent	—	LB-T-5W-E	Plaster white	6.8Y8.9/0.2 near equivalent	9003 near equivalent	—	Panel color
	Panel (Standard)	T-PSA-5BB-E	Shadow black	7.2BG2.9 / 0.6 near equivalent	7043 near equivalent	Grid	T-PSA-5AW-E	Plaster white	6.8Y8.9/0.2 near equivalent	9003 near equivalent	Grid	Panel color
	Panel (Prevention)	T-PSAE-5BB-E	Shadow black	7.2BG2.9 / 0.6 near equivalent	7043 near equivalent	Grid	T-PSAE-5AW-E	Plaster white	6.8Y8.9/0.2 near equivalent	9003 near equivalent	Grid	Panel color
	Wireless kit	RCN-T-5BB-E2	Shadow black	7.2BG2.9 / 0.6 near equivalent	7043 near equivalent	—	RCN-T-5AW-E2	Plaster white	6.8Y8.9/0.2 near equivalent	9003 near equivalent	—	Panel color Latest software ※2
	Motion sensor kit	LB-T-5BB-E	Shadow black	7.2BG2.9 / 0.6 near equivalent	7043 near equivalent	—	LB-T-5W-E	Plaster white	6.8Y8.9/0.2 near equivalent	9003 near equivalent	—	Panel color
	Panel (Standard)	TC-PSAG-5AW-E	Fine snow	8.0Y9.3 / 0.1 near equivalent	9001 near equivalent	Grid	TC-PSA-5AW-E	Fine snow	8.0Y9.3 / 0.1 near equivalent	9001 near equivalent	Honeycomb	Inlet grille ※1
	Panel (Prevention)	TC-PSAGE-5AW-E	Fine snow	8.0Y9.3 / 0.1 near equivalent	9001 near equivalent	Grid	TC-PSAE-5AW-E	Fine snow	8.0Y9.3 / 0.1 near equivalent	9001 near equivalent	Honeycomb	Inlet grille ※1
FDTc	Wireless kit	RCN-TC-5AW-E3	Fine snow	8.0Y9.3 / 0.1 near equivalent	9001 near equivalent	—	RCN-TC-5AW-E2	Fine snow	8.0Y9.3 / 0.1 near equivalent	9001 near equivalent	—	Latest software ※2
	Motion sensor kit	LB-TC-5W-E	Fine snow	8.0Y9.3 / 0.1 near equivalent	9001 near equivalent	—	LB-TC-5W-E	Fine snow	8.0Y9.3 / 0.1 near equivalent	9001 near equivalent	—	No change
	Panel (Standard)	TC-PSA-5AW-E	Fine snow	8.0Y9.3 / 0.1 near equivalent	9001 near equivalent	Honeycomb	TC-PSA-5AW-E	Fine snow	8.0Y9.3 / 0.1 near equivalent	9001 near equivalent	Honeycomb	No change
	Panel (Prevention)	TC-PSAE-5AW-E	Fine snow	8.0Y9.3 / 0.1 near equivalent	9001 near equivalent	Honeycomb	TC-PSAE-5AW-E	Fine snow	8.0Y9.3 / 0.1 near equivalent	9001 near equivalent	Honeycomb	No change
	Wireless kit	RCN-TC-5AW-E3	Fine snow	8.0Y9.3 / 0.1 near equivalent	9001 near equivalent	—	RCN-TC-5AW-E2	Fine snow	8.0Y9.3 / 0.1 near equivalent	9001 near equivalent	—	Latest software ※2
	Motion sensor kit	LB-TC-5W-E	Fine snow	8.0Y9.3 / 0.1 near equivalent	9001 near equivalent	—	LB-TC-5W-E	Fine snow	8.0Y9.3 / 0.1 near equivalent	9001 near equivalent	—	No change

※ 1,2 : See next page

※1 Regarding change of the inlet grille

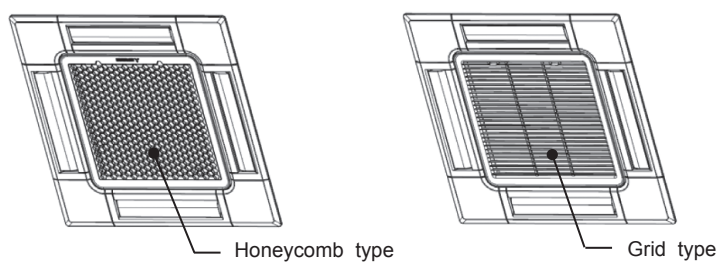

※2 Regarding change of the latest software

In order to operate the prevention function from the wireless remote control, the current model needs to connect with the wired remote control once and activate the Anti draft setting (ON), however the new model can operate the prevention function without connecting to the wired remote control.

2. Indoor unit compatibility

Indoor model	Accessories	Model name	Indoor compatibility					
			Split type				Multi type	
			FDT-VG	FDT-VH	FDTC-VG	FDTC-VH	FDT-KXZE1	FDTC-KXZE1
FDT	Panel (Standard)	T-PSA-5BW-E T-PSA-5AW-E T-PSA-5BB-E	○	○	—	—	○	—
	Panel (Prevention)	T-PSAE-5BW-E T-PSAE-5AW-E T-PSAE-5BB-E	○	○	—	—	○	—
	Wireless kit	RCN-T-5BW-E2 RCN-T-5AW-E2 RCN-T-5BB-E2	○	○	—	—	○	—
	Motion sensor kit	LB-T-5BW-E LB-T-5W-E LB-T-5BB-E	○	○	—	—	○	—
FDTC	Panel (Standard)	TC-PSAG-5AW-E TC-PSA-5AW-E	—	—	○	○	—	○
	Panel (Prevention)	TC-PSAGE-5AW-E TC-PSAE-5AW-E	—	—	○	○	—	○
	Wireless kit	RCN-TC-5AW-E3 RCN-TC-5AW-E2	—	—	○	○	—	○
	Motion sensor kit	LB-TC-5W-E	—	—	○	○	—	○

3. Drawing number (Reference page)

Indoor model	Accessories	Model name	Drawing number (Reference page)			
			Outline/Spec		Wiring diagram	Installation manual
			VG,VH : 40-71 KXZ : 28-71	VG,VH : 100-140 KXZ : 90-160		
FDT	Panel (Standard)	T-PSA-5BW-E T-PSA-5AW-E T-PSA-5BB-E	PJF000Z733 (Page 6) PJF000Z741 (Page 8)	PJF000Z734 (Page 7) PJF000Z742 (Page 9)	PJF000Z735 (Page 10) PJF000Z743 (Page 11)	PJF012D051 (Page 12) PJF012D037 (Page 16)
	Panel (Prevention)	T-PSAE-5BW-E T-PSAE-5AW-E T-PSAE-5BB-E				
	Wireless kit	RCN-T-5BW-E2 RCN-T-5AW-E2 RCN-T-5BB-E2	PJF000Z632 (Page 18)			PJF012D035C (Page 19)
	Motion sensor kit	LB-T-5BW-E LB-T-5W-E LB-T-5BB-E	PJF000Z730 (Page 27)			PJF012D036 (Page 28)

Indoor model	Accessories	Model name	Drawing number (Reference page)			
			Outline/Spec		Wiring diagram	Installation manual
			VG,VH : 25-60 KXZ : 15-56			
FDTC	Panel (Standard)	TC-PSAG-5AW-E TC-PSA-5AW-E	PJF000Z755 (Page 33) PJF000Z738 (Page 34) PJF000Z756 (Page 35) PJF000Z745 (Page 36)	PJF000Z739 (Page 37) PJF000Z746 (Page 38)	PJF012D509 (Page 39) PJF012D503 (Page 43)	
	Panel (Prevention)	TC-PSAGE-5AW-E TC-PSAE-5AW-E				
	Wireless kit	RCN-TC-5AW-E3 RCN-TC-5AW-E2	PJF000Z634 (Page 47)		PJF012D506B (Page 48)	
	Motion sensor kit	LB-TC-5W-E	PJF000Z509 (Page 56)		PJF012D504 (Page 57)	

CEILING CASSETTE-4 WAY TYPE (FDT series)

CONTENTS

1. EXTERIOR DIMENSIONS	6
2. ELECTRICAL WIRING	10
3. INSTALLATION OF INDOOR UNIT	12
4. INSTALLATION OF PANEL	16
5. WIRELESS KIT	18
6. MOTION SENSOR KIT	27

1. EXTERIOR DIMENSIONS

Ceiling cassette-4 way type (FDT)

Models FDT40VG, 50VG, 60VG, 71VG

FDT40VH, 50VH, 60VH, 71VH

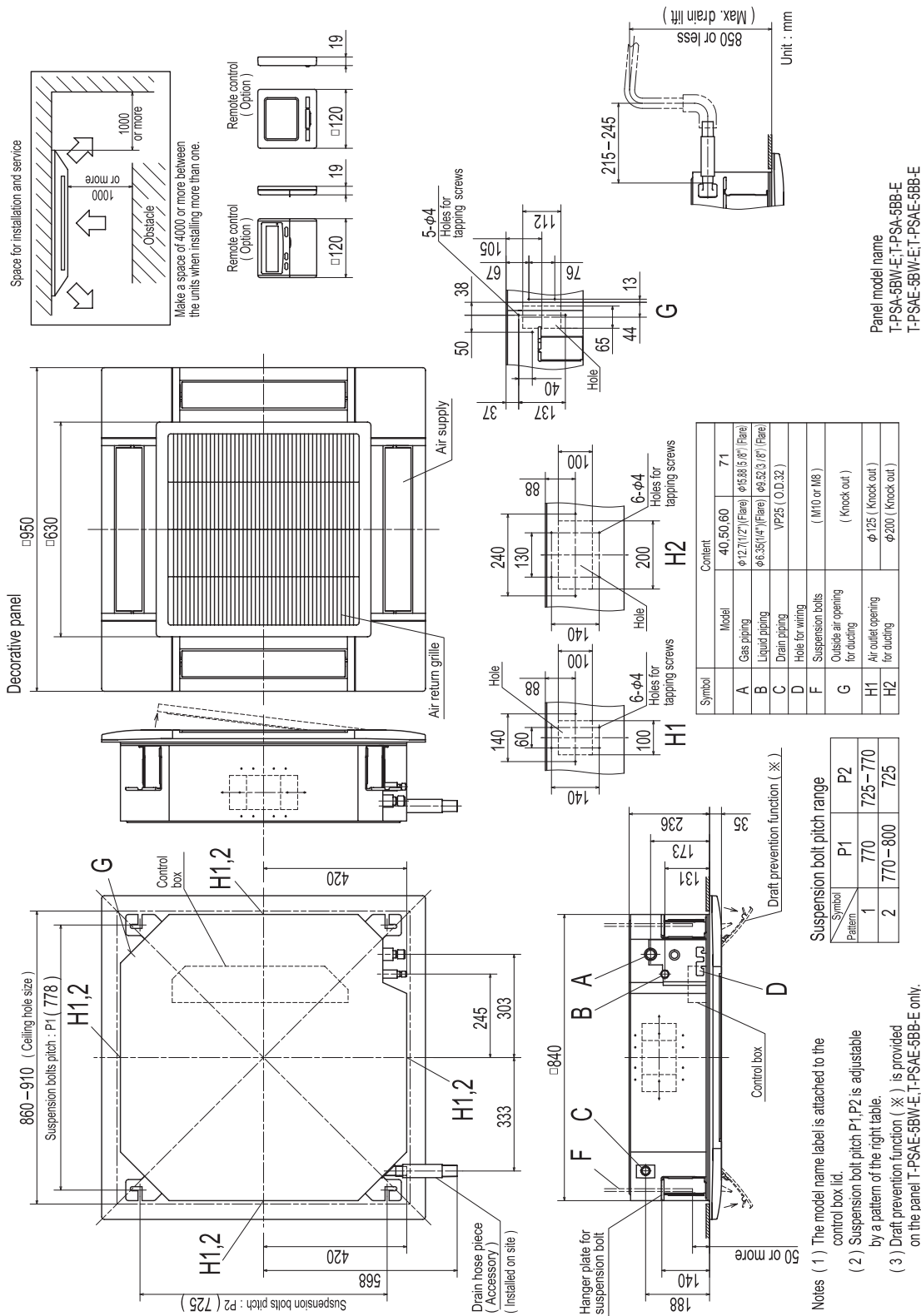

Symbol	Model	Content
A	Gas piping	40, 50, 60, 71 φ12.7(1/2") (Flare) φ15.8(5/8") (Flare)
B	Liquid piping	φ6.3(1/4") (Flare) φ8.32(3/8") (Flare)
C	Drain piping	VP25 (O.D. 32)
D	Hole for wiring	(M10 or M8)
F	Suspension bolts	(Knock out)
G	Outside air opening for ducting	(Knock out)
H1	Air outlet opening for ducting	φ125 (Knock out)
H2		φ200 (Knock out)

Suspension bolt pitch range	
Symbol	Pattern
P1	P2
1	770
2	770-800
	725-770
	725

Notes (1) The model name label is attached to the control box lid.
 (2) Suspension bolt pitch P1, P2 is adjustable by a pattern of the right table.
 (3) Draft prevention function (※) is provided on the panel T-PSAE-5BW-E, T-PSAE-5BB-E only.

Panel model name
 T-PSA-5BW-E, T-PSA-5BB-E
 T-PSAE-5BW-E, T-PSAE-5BB-E

Models FDT28KXZE1, 36KXZE1, 45KXZE1, 56KXZE1, 71KXZE1

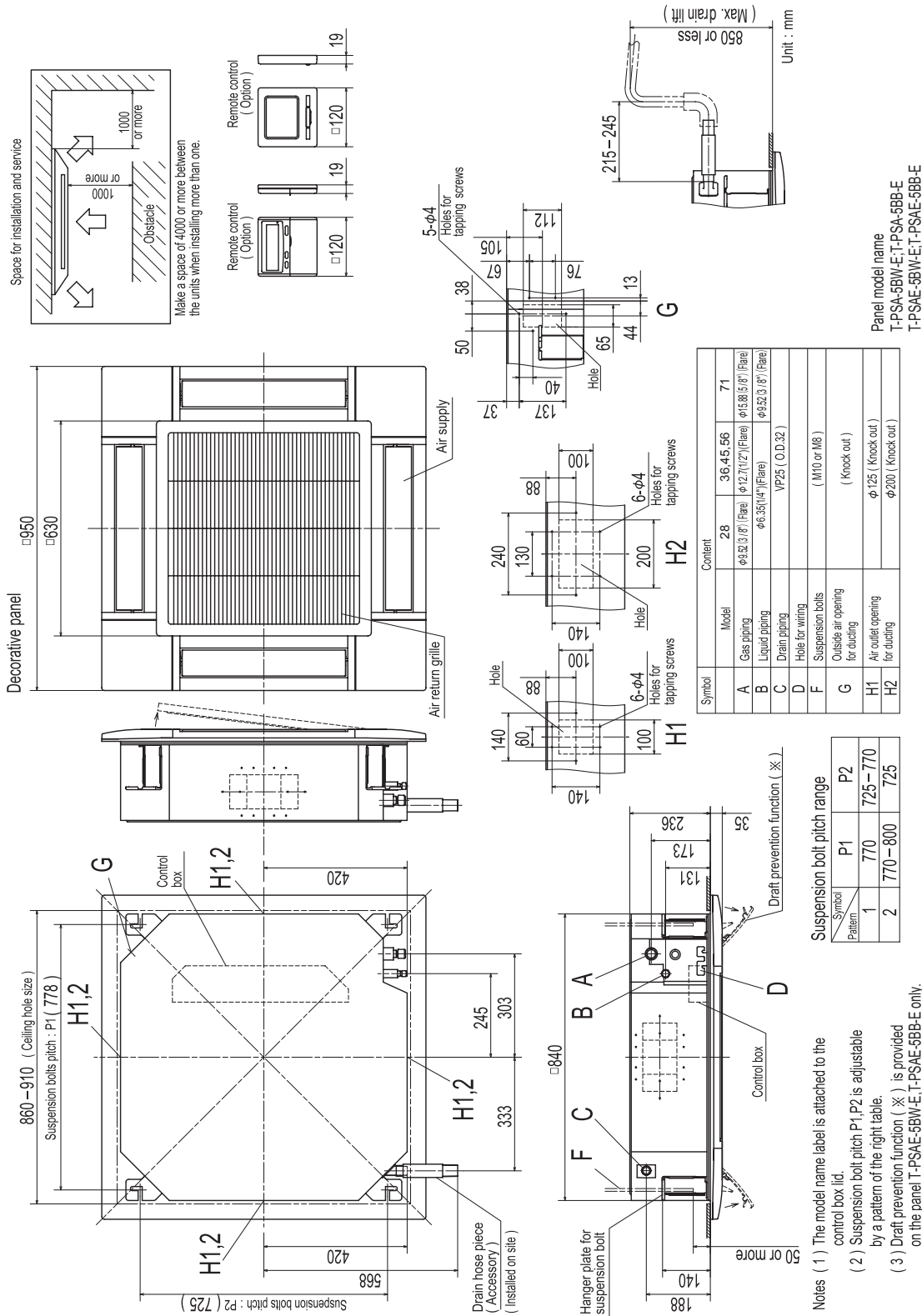

Notes (1) The model name label is attached to the control box lid.
 (2) Suspension bolt pitch P1, P2 is adjustable by a pattern of the right table.
 (3) Draft prevention function (※) is provided on the panel T-PSAE-5BW-E, T-PSAE-5BB-E only.

Models FDT90KXZE1, 112KXZE1, 140KXZE1, 160KXZE1

Symbol	Content
A	Gas piping φ15.88(5/8") (Flare)
B	Liquid piping φ9.52(3/8") (Flare)
C	Drain piping VP25(O.D.32)
D	Hole for wiring
F	Suspension bolts (M10 or M8)
G	Outside air opening (Knock out)
H1	Air outlet opening for ducting φ125 (Knock out)
H2	Air outlet opening for ducting φ200 (Knock out)

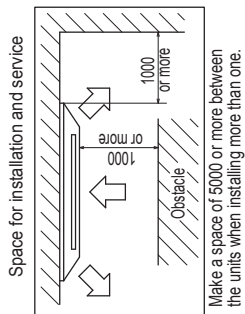
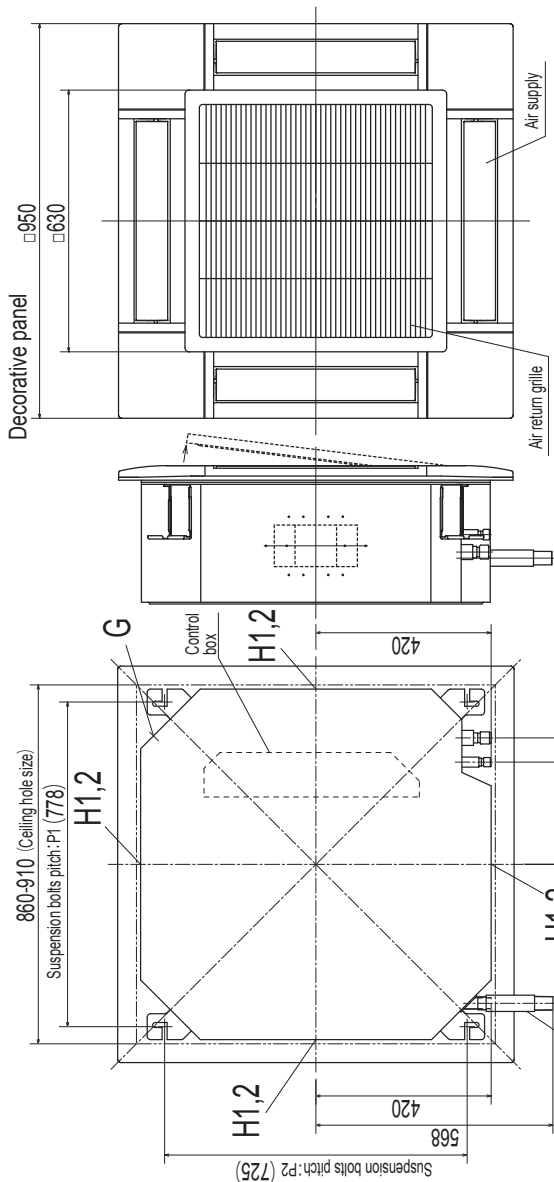

Make a space of 5000 or more between the units when installing more than one.

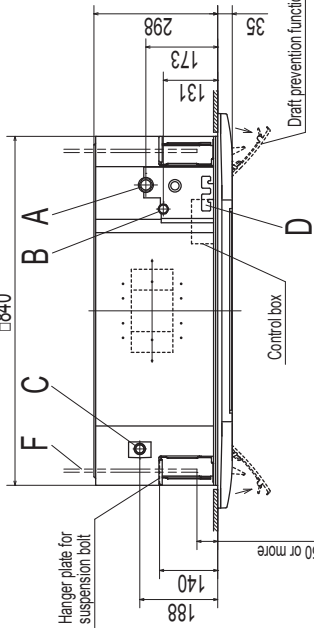

Symbol	Suspension bolt pitch range	
	P1	P2
1	770	725-770
2	770-800	725

- Notes (1) The model name label is attached to the control box lid.
 (2) Suspension bolt pitch P1, P2 is adjustable by a pattern of the right table.
 (3) Draft prevention function (*1) is provided on the panel T-PSAE-5BW-E, T-PSAE-5BB-E only.

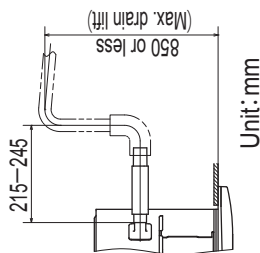

(Max. drain lift)

Unit: mm

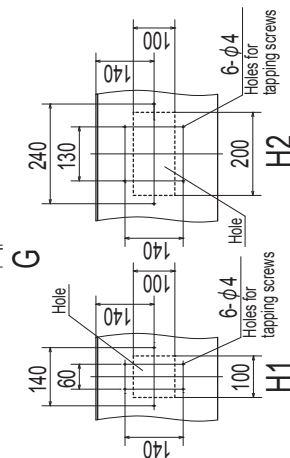

Panel model name
 T-PSA-5BW-E, T-PSA-5BB-E
 T-PSAE-5BW-E, T-PSAE-5BB-E

2. ELECTRICAL WIRING

Ceiling cassette-4 way type (FDT)

Models FDT40VG, 50VG, 60VG, 71VG, 100VG, 125VG, 140VG
 FDT40VH, 50VH, 60VH, 71VH, 100VH, 125VH, 140VH

Meaning of marks

Item	Description
AM1~4	Draft prevention function motor
CNB~Z	Connector
DM	Drain pump motor
F1,2	Fuse
FMI	Fan motor
FS	Float switch
HS	Humidity sensor
L	Reactor
LED-2	Indication lamp (Green-Normal operation)
LED-3	Indication lamp (Red-Inspection)
LM1~4	Lower motor
PIS	Motion sensor
SW2	Remote controller communication address
SW5	Plural units Master/ Slave setting
SW6	Model capacity setting
SW7-1	Operation check/drain pump motor test run
TB1	Terminal block (Power source) (□ mark)
TB2	Terminal block (Signal line) (□ mark)
Thc	Temperature sensor (Remote control)
Thi-A	Temperature sensor (Return air)
Thi-R1,2,3	Temperature sensor (Heat exchanger)

Color marks

Mark	Color	Mark	Color
BK	Black	WH	White
BL	Blue	YE	Yellow
BR	Brown	GY	Gray
OR	Orange	YE/GN	Yellow/Green
RD	Red		

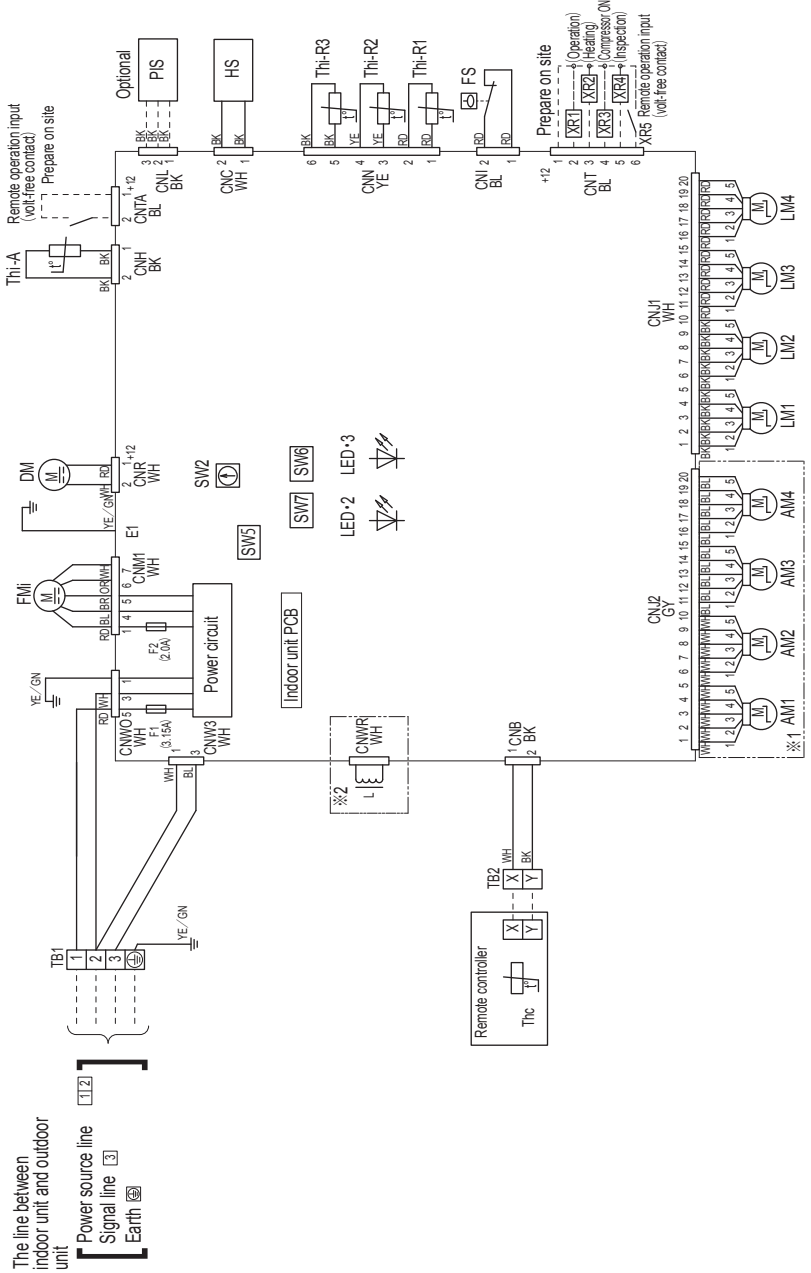

- Notes
1. --- indicates wiring on site.
 2. See the wiring diagram of outside unit about the line between indoor unit and outdoor unit.
 3. Use twin core cord (0.3mm²) at remote controller line. See spec. sheet of remote controller in case that the total length is more than 100m.
 4. Do not put remote controller line alongside power source line.
 5. Section 1 (※1) is provided on the panel T-PSAE-5BW-E, T-PSAE-5BB-E only.
 6. Section 2 (※2) is provided on the models 100, 125 only.

Models FDT28KXZE1, 36KXZE1, 45KXZE1, 56KXZE1, 71KXZE1, 90KXZE1, 112KXZE1, 140KXZE1, 160KXZE1

Meaning of marks

Item	Description
AM1~4	Draft prevention function motor
CNA~Z	Connector
DM	Drain pump motor
F1,2	Fuse
FMI	Fan motor
FS	Float switch
HS	Humidity sensor
JSL1	Spare superlink connector change
LED•2	Indication lamp (Green-Normal operation)
LED•3	Indication lamp (Red-Inspection)
LM1~4	Louver motor
PIS	Motion sensor
SM	Stepping motor (For electronic expansion valve)
SW1	Indoor unit address tens place
SW2	Indoor unit address ones place
SW3	Outdoor unit address tens place
SW4	Outdoor unit address ones place
SW5-1	Automatic adjustment / Fixed previous version of superlink protocol
SW5-2	Indoor unit address hundreds place
SW6	Model capacity setting
SW7-1	Operation check/drain dump motor test run
TB1	Terminal block (Power source) (□ mark)
TB2	Terminal block (Signal line) (□ mark)
ThC	Temperature sensor (Remote control)
Thi-A	Temperature sensor (Return air)
Thi-R1,2,3	Temperature sensor (Heat exchanger)

Color marks

Mark	Color	Mark	Color
BK	Black	WH	White
BL	Blue	YE	Yellow
BR	Brown	GY	Gray
OR	Orange	YE/GN	Yellow/Green
RD	Red		

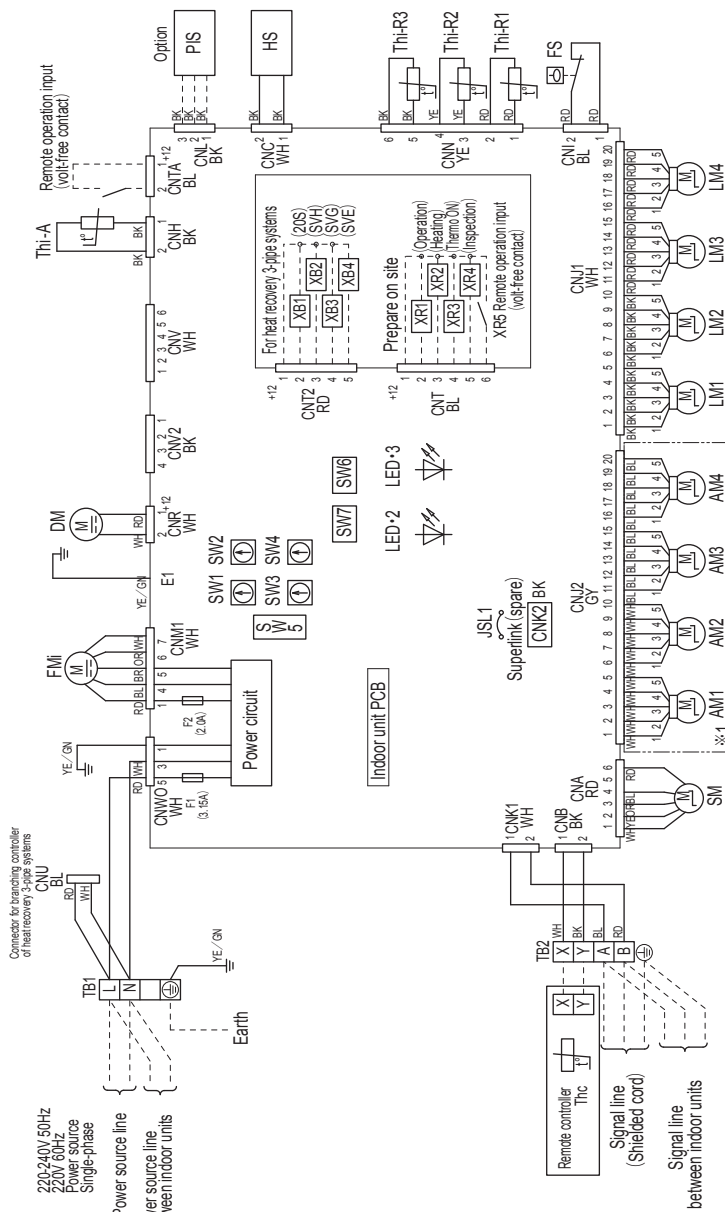

- Notes
1. --- indicates wiring on site.
 2. Use twin core shielded cord (0.75-1.25mm²) at signal line between indoor unit and outdoor unit, and signal line between indoor units.
 3. Use twin core cord (0.3mm²) at remote controller line.
 4. Do not put signal line and remote controller line alongside power source line. See spec sheet of remote controller in case that the total length is more than 100m.
 5. Section 1 (※1) is provided on the panel TPSAE-5BIV-E, TPSAE-5BB-E only.



3. INSTALLATION OF INDOOR UNIT

Ceiling cassette-4 way type(FDT)

























PJF012D051

This manual is for the installation of the indoor unit.
For the panel installation, refer to page 16. For wireless kit installation, refer to page 19. For motion sensor kit installation, refer to page 28. This unit must always be used with the panel.





























SAFETY PRECAUTIONS

- Read the "SAFETY PRECAUTIONS" carefully first of all and then strictly follow it during the installation work in order to protect yourself.
- The precautionary items mentioned below are distinguished into two levels, **⚠️ WARNING** and **⚠️ CAUTION**.
⚠️ WARNING: Wrong installation would cause serious consequences such as injuries or death.
⚠️ CAUTION: Wrong installation might cause serious consequences depending on circumstances.
 Both mentions the important items to protect your health and safety so strictly follow them by any means.
- The meanings of "Marks" used here are as shown on the right:
 Never do it under any circumstances.  Always do it according to the instruction.
- After completing the installation, do commissioning to confirm there are no abnormalities, and explain to the customers about "SAFETY PRECAUTIONS", correct operation method and maintenance method (air filter cleaning, operation method and temperature setting method) with user's manual of this unit.
Ask your customers to keep this installation manual together with the user's manual. Also, ask them to hand over the user's manual to the new user when the owner is changed.

⚠️ WARNING

- **Installation should be performed by the specialist.**
If you install the unit by yourself, it may lead to serious trouble such as water leakage, electric shock, fire, and injury due to overturn of the unit. 
- **Install the system correctly according to these installation manuals.**
Improper installation may cause explosion, injury, water leakage, electric shock, and fire. 
- **Check the density referred by the formula (accordance with ISO5149).**
If the density exceeds the limit density, please consult the dealer and installate the ventilation system. 
- **Use the genuine accessories and the specified parts for installation.**
If parts unspecified by our company are used it could cause water leakage, electric shock, fire, and injury due to overturn of the unit. 
- **Ventilate the working area well in case the refrigerant leaks during installation.**
If the refrigerant contacts the fire, toxic gas is produced. 
In case of R32, the refrigerant could be ignited because of its flammability. 
- **Install the unit in a location that can hold heavy weight.**
Improper installation may cause the unit to fall leading to accidents. 
- **Install the unit properly in order to be able to withstand strong winds such as typhoons, and earthquakes.**
Improper installation may cause the unit to fall leading to accidents. 
- **Do not mix air in to the cooling cycle on installation or removal of the air-conditioner.**
If air is mixed in, the pressure in the cooling cycle will rise abnormally and may cause explosion and injuries. 
- **Be sure to have the electrical wiring work done by qualified electrical installer, and use exclusive circuit.**
Power source with insufficient capacity and improper work can cause electric shock and fire. 
- **Use specified wire for electrical wiring, fasten the wiring to the terminal securely, and hold the cable securely in order not to apply unexpected stress on the terminal.**
Loose connections or hold could result in abnormal heat generation or fire. 
- **Arrange the electrical wires in the control box properly to prevent them from rising. Fit the lid of the services panel properly.**
Improper fitting may cause abnormal heat and fire. 
- **Check for refrigerant gas leakage after installation is completed.**
If the refrigerant gas leaks into the house and comes in contact with a fan heater, a stove, or an oven, toxic gas is produced. 
- **Use the specified pipe, flare nut, and tools for R32 or R410A.**
Using existing parts (R22) could cause the unit failure and serious accident due to explosion of the cooling cycle. 
- **Tighten the flare nut according to the specified method by with torque wrench.**
If the flare nut were tightened with excess torque, it could cause burst and refrigerant leakage after a long period. 
- **Do not put the drainage pipe directly into drainage channels where poisonous gases such as sulfide gas can occur.**
Poisonous gases will flow into the room through drainage pipe and seriously affect the user's health and safety. This can also cause the corrosion of the indoor unit and a resultant unit failure or refrigerant leak. 
- **Connect the pipes for refrigeration circuit securely in installation work before compressor is operated.**
If the compressor is operated when the service valve is open without connecting the pipe, it could cause explosion and injuries due to abnormal high pressure in the system. 
- **Stop the compressor before removing the pipe after shutting the service valve on pump down work.**
If the pipe is removed when the compressor is in operation with the service valve open, air would be mixed in the refrigeration circuit and it could cause explosion and injuries due to abnormal high pressure in the cooling cycle. 
- **Only use prescribed option parts. The installation must be carried out by the qualified installer.**
If you install the system by yourself, it can cause serious trouble such as water leaks, electric shocks, fire. 
- **Do not repair by yourself. And consult with the dealer about repair.**
Improper repair may cause water leakage, electric shock or fire. 
- **Consult the dealer or a specialist about removal of the air-conditioner.**
Improper installation may cause water leakage, electric shock or fire. 
- **Turn off the power source during servicing or inspection work.**
If the power is supplied during servicing or inspection work, it could cause electric shock and injury by the operating fan. 
- **Do not run the unit when the panel or protection guard are taken off.**
Touching the rotating equipment, hot surface, or high voltage section could cause an injury to be caught in the machine, to get burned, or electric shock. 
- **Shut off the power before electrical wiring work.**
It could cause electric shock, unit failure and improper running. 

⚠️ CAUTION

- **Perform earth wiring surely.**
Do not connect the earth wiring to the gas pipe, water pipe, lightning rod and telephone earth wiring. Improper earth could cause unit failure and electric shock due to a short-circuit. 
- **Earth leakage breaker must be installed.**
If the earth leakage breaker is not installed, it can cause electric shocks. 
- **Use the circuit breaker of correct capacity. Circuit breaker should be the one that disconnect all poles under over current.**
Using the incorrect one could cause the system failure and fire. 
- **Do not use any materials other than a fuse of correct capacity where a fuse should be used.**
Connecting the circuit by wire or copper wire could cause unit failure and fire. 
- **Do not install the indoor unit near the location where there is possibility of flammable gas leakages.**
If the gas leaks and gathers around the unit, it could cause fire. 
- **Do not install and use the unit where corrosive gas (such as sulfuric acid gas etc.) or flammable gas (such as thinner, petroleum etc.) may be generated or accumulated, or volatile flammable substances are handled.**
It could cause the corrosion of heat exchanger, breakage of plastic parts etc. And inflammable gas could cause fire. 
- **Secure a space for installation, inspection and maintenance specified in the manual.**
Insufficient space can result in accident such as personal injury due to falling from the installation place. 
- **Do not use the indoor unit at the place where water splashes such as laundry.**
Indoor unit is not waterproof. It could cause electric shock and fire. 
- **Do not use the indoor unit for a special purpose such as food storage, cooling for precision instrument, preservation of animals, plants, and a work of art.**
It could cause the damage of the items. 
- **Do not install nor use the system near equipments which generate electromagnetic wave or high harmonics.**
Equipments like inverter equipment, private power generator, high-frequency medical equipment, or telecommunication equipment might influence the air-conditioner and cause a malfunction and breakdown. Or the air conditioner might influence medical equipments or telecommunication equipments, and obstruct their medical activity or cause jamming. 
- **Do not install the remote control at the direct sunlight.**
It could cause breakdown or deformation of the remote control. 
- **Do not install the indoor unit at the place listed below.**
 - Places where flammable gas could leak.
 - Places where carbon fiber, metal powder or any powder is floated.
 - Place where the substances which affect the air conditioner are generated such as sulfide gas, chloride gas, acid, alkali or ammoniac atmospheres.
 - Places exposed to oil mist or steam directly.
 - On vehicles and ships
 - Places where machinery which generates high harmonics is used.
 - Places where cosmetics or special sprays are frequently used.
 - Highly salted area such as beach.
 - Heavy snow area
 - Places where the system is affected by smoke from a chimney.
 - Altitude over 1000m
- **Do not install the indoor unit in the locations listed below (Be sure to install the indoor unit according to the installation manual for each model because each indoor unit has each limitation)**
 - Locations with any obstacles which can prevent inlet and outlet air of the unit
 - Locations where vibration can be amplified due to insufficient strength of structure.
 - Locations where the infrared receiver is exposed to the direct sunlight or the strong light beam. (In case of the infrared specification unit)
 - Locations where an equipment affected by high harmonics is placed. (TV set or radio receiver is placed within 5m)
 - Locations where drainage cannot run off safely. It can affect performance or function and etc.
 - Do not install the motion sensor mounting panel at following places. It could cause detection error, incapacity of detection, or characteristic degradation.
 - Place where vibration is applied to it for a long period of time.
 - Place where static electricity or electromagnetic wave generates.
 - Place where it is exposed to high temperature or humidity for a long period of time.
 - Dusty place or where the lens face could be fouled or damaged.
- **Do not put any valuables which will break down by getting wet under the air-conditioner.**
Condensation could drop when the relative humidity is higher than 80% or drain pipe is clogged, and it damages user's belongings. 
- **Do not use the base frame for the outdoor unit which is corroded or damaged after a long period of use.**
It could cause the unit falling down and injury. 
- **Pay attention not to damage the drain pan by weld sputter when brazing work is done near the unit.**
If sputter entered into the unit during brazing work, it could cause damage (pinhole) of drain pan and leakage of water. To avoid damaging, keep the indoor unit packed or cover the indoor unit. 
- **Install the drain pipe to drain the water surely according to the installation manual.**
Improper connection of the drain pipe may cause dropping water into room and damaging user's belongings. 
- **Be sure to perform air tightness test by pressurizing with nitrogen gas after completed refrigerant piping work.**
If the density of refrigerant exceeds the limit in the event of refrigerant leakage in the small room, lack of oxygen can occur, which can cause serious accidents. 
- **For drain pipe installation, be sure to make descending slope of greater than 1/100, not to make traps, and not to make air-bleeding.**
Check if the drainage is correctly done during commissioning and ensure the space for inspection and maintenance. 
- **Ensure the insulation on the pipes for refrigeration circuit so as not to condense water.**
Incomplete insulation could cause condensation and it would wet ceiling, floor, and any other valuables. 
- **Do not install the outdoor unit where is likely to be a nest for insects and small animals.**
Insects and small animals could come into the electronic components and cause breakdown and fire. Instruct the user to keep the surroundings clean. 
- **Pay extra attention, carrying the unit by hand.**
Carry the unit with 2 people if it is heavier than 20kg. Do not use the plastic straps but the grabbing place, moving the unit by hand. Use protective gloves in order to avoid injury by the aluminum fin. 
- **Make sure to dispose of the packaging material.**
Leaving the materials may cause injury as metals like nail and woods are used in the package. 
- **Do not operate the system without the air filter.**
It may cause the breakdown of the system due to clogging of the heat exchanger. 
- **Do not touch any button with wet hands.**
It could cause electric shock. 
- **Do not touch the refrigerant piping with bare hands when in operation.**
The pipe during operation would become very hot or cold according to the operating condition, and it could cause a burn or frostbite. 
- **Do not clean up the air-conditioner with water.**
It could cause electric shock. 
- **Do not turn off the power source immediately after stopping the operation.**
Be sure to wait for more than 5 minutes. Otherwise it could cause water leakage or breakdown. 
- **Do not control the operation with the circuit breaker.**
It could cause fire or water leakage. In addition, the fan may start operation unexpectedly and it may cause injury. 

① Before installation

- Install correctly according to the installation manual.
- Confirm the following points:
 - Unit type/Power source specification
 - Pipes/Wires/Small parts
 - Accessory items

When moving the indoor unit, hold only the hanging hardware (4 places) only, with care not to apply forces to any other parts of the unit (particularly the refrigerant pipe, drain pipe, and resin parts).

Accessory item

For unit hanging		For refrigerant pipe			For drain pipe			
Flat washer (M10)	Level gauge	Pipe cover(big)	Pipe cover (small)	Strap	Pipe cover(big)	Pipe cover(small)	Drain hose	Hose clamp
8	1	1	1	4	1	1	1	1
For unit hanging	For height adjustment and level gauge	For heat insulation of gas pipe	For heat insulation of liquid tube	For pipe cover fixing	For heat insulation of drain socket	For heat insulation of drain socket	For drain pipe connecting	For drain hose mounting

② Selection of installation location for the indoor unit

- Select the suitable areas to install the unit under approval of the user.
 - Areas where the indoor unit can deliver hot and cold wind sufficiently. Suggest to the user to use a circulator if the ceiling height is over 3m to avoid warm air being accumulated on the ceiling.
 - In case of the panel having the motion sensor, the installation height must be no higher than 4 m. It could reduce the sensitivity of motion sensor, disabling the detection.
 - Areas where there is enough space to install and service.
 - Areas where it can be drained properly. Areas where drain pipe descending slope can be taken.
 - Areas where there is no obstruction of air flow on both air return grille and air supply port.
 - Areas where fire alarm will not be accidentally activated by the air-conditioner.
 - Areas where the supply air does not short-circuit.
 - Areas where it is not influenced by draft air.
 - Areas not exposed to direct sunlight.
 - Areas where dew point is lower than around 28°C and relative humidity is lower than 80%.

This indoor unit is tested under the condition of JIS (Japan Industrial Standard) high humidity condition and confirmed there is no problem. However, there is some risk of condensation drop if the air-conditioner is operated under the severer condition than mentioned above.

If there is a possibility to use it under such a condition, attach additional insulation of 10 to 20mm thick for entire surface of indoor unit, refrigeration pipe and drain pipe.
- Check if the place where the air-conditioner is installed can hold the weight of the unit. If it is not able to hold, reinforce the structure with boards and beams strong enough to hold it. If the strength is not enough, it could cause injury due to unit falling.
- If there are 2 units of wireless type, keep them away for more than 6m to avoid malfunction due to cross communication.
- When plural indoor units are installed nearby, keep them away for more than 4 to 5m.

Space for installation and service

- When it is not possible to keep enough space between indoor unit and wall or between indoor units, close the air supply port where it is not possible to keep space and confirm there is no short-circuit of air flow.
- Install the indoor unit at a height of more than 2.5m above the floor.

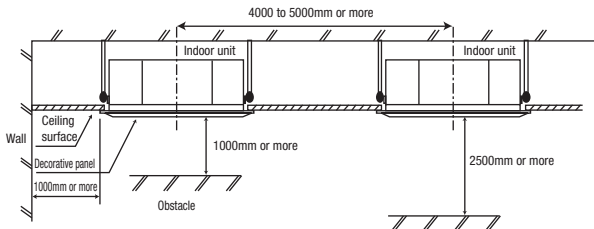

Set blow-out pattern

- Select the most proper number of blow-out air supply port direction from 4 way, 3 way or 2 way according to the shape of the room and installation position. (1 way is not available.)
- If it is necessary to change the number of air supply port, prepare the covering materials. (sold as accessory)
- Instruct the user not to use low fan speed when 2 way or 3 way air supply is used.
- Do not use 2 way air supply port under high temperature and humidity environment. (Otherwise it could cause condensation and leakage of water.)
- It is possible to set the air flow direction port by port independently. Refer to the user's manual for details.

③ Preparation before installation

- If suspension bolt becomes longer, do reinforcement of earthquake resistant.
 - For grid ceiling
 - When suspension bolt length is over 500mm, or the gap between the ceiling and roof is over 700mm, apply earthquake resistant brace to the bolt.
 - In case the unit is hanged directly from the slab and is installed on the ceiling plane which has enough strength.
 - When suspension bolt length is over 1000mm, apply the earthquake resistant brace to the bolt.
- Prepare four (4) sets of suspension bolt, nut and spring washer (M10 or M8) on site.

Ceiling opening, Suspension bolts pitch, Pipe position

※It is possible the suspension bolts pitch to adjust according to the this table.

Type	Mark	P1	P2
1		770	725-770
2		770-800	725

Series	Type	a	d	f	g	h
Single Split (PAC) series	40 to 71 type	236	37	105	88	67
	100 to 140 type	298	99	167	140	129
VRF (KX) series	28 to 71 type	236	37	105	88	67
	90 to 160 type	298	99	167	140	129

Symbol	
A	Gas piping
B	Liquid piping
C	Drain piping
D	Hole for wiring
F	Suspension bolts
G	Outside air opening for ducting
H1	Air outlet opening for ducting
H2	Air outlet opening for ducting

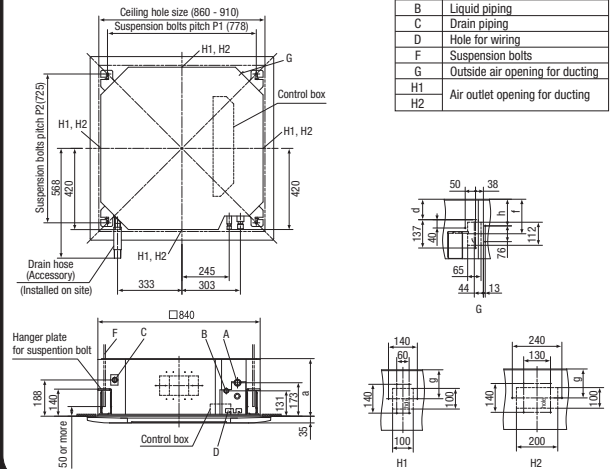

④ Installation of indoor unit

Work procedure

- Set the suspension bolt length to about 50mm from the ceiling.
- Temporarily locate the lower nuts of the suspension bolts (4 places) at a position approximately 150mm from the ceiling.
- Temporarily locate the upper nuts of the suspension bolts (4 places) at positions sufficiently distance from the lower nuts so that they do not interfere with the suspension of the indoor unit and with its height adjustment.
- Set the upper nuts of the suspension bolts and upper washers (4 places) at positions sufficiently distance from the lower nuts. Then, push and insert the temporary fixing carton of washers (*1) onto suspension bolts. Make sure that the upper washers do not slide down.
- Suspend the indoor unit.
- After suspending the indoor unit, mount the level gauge (*2) to the air outlet of the indoor unit, and adjust the suspension height of the indoor unit. Loosen the upper nuts (4 places), and adjust the suspension height using the lower nuts (4 places). Confirm there is no slack between the lower nuts and flat washers of the indoor unit hanger plate (4 places).
- Remove the temporary fixing carton of washers (from all 4 places).
- Make sure that the indoor unit is installed horizontally. Confirm the levelness of the indoor unit using a level gauge or transparent hose filled with water. (Keep the height difference at both ends of the indoor unit within 3mm.)
- Tighten the upper nuts of the suspension bolts (4 places).

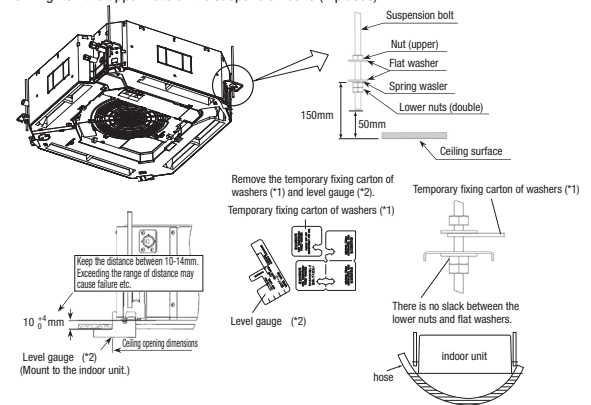

④ Installation of indoor unit (continued)

Protection of the indoor unit

- If it is not possible to install the panel for a while or if attaching the ceiling board after installing the indoor unit, protect the indoor unit by using upper carton.

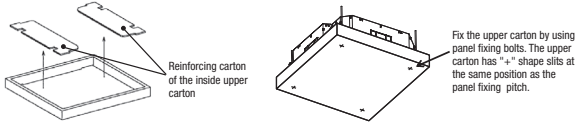

Caution

- Do not adjust the unit height by adjusting the upper nuts. Doing so will cause unexpected stress on the indoor unit and cause the unit to become deformed, prevent the panel from being installed, and be generated fan interference noise.
- Make sure that the indoor unit is installed horizontally and set the appropriate gap between the underside of the unit and the ceiling plane. Improper installation may cause air leakage, dew condensation, water leakage and noise.
- Even after the panel has been installed, the unit height can still be finely adjusted. Refer to the panel installation manual for details.
- Make sure there is no gap between the panel and the ceiling surface, and between the panel and the indoor unit. Any gap may cause air and/or water to leak, or condensation to form.

⑤ Refrigerant pipe

Caution

- Be sure to use new pipes for the refrigerant pipes. Use the flare nut attached to the product. Regarding whether existing pipes can be reused or not, and the washing method, refer to the instruction manual of the outdoor unit, catalogue or technical data.
- 1) In case of reuse: Do not use old flare nut, but use the nut attached to the unit.
- 2) In case of reuse: Flare the end of pipe replaced partially for R32 or R410A.

⚠️ **WARNING** : When flared joints are reused indoors, the flare part shall be re-fabricated. (only for R32)

Pipe diameter d mm	Min. pipe wall thickness mm	Protruding dimension for flare, mm		Flare O.D. D mm	Flare nut tightening torque N·m
		Rigid (Clutch type) For R32 For R410A	Conventional tool		
6.35	0.8	0 - 0.5	0.7 - 1.3	8.9 - 9.1	14 - 18
9.52	0.8			12.8 - 13.2	34 - 42
12.7	0.8			16.2 - 16.6	49 - 61
15.88	1			19.3 - 19.7	68 - 82
19.05	1.2			23.6 - 24.0	100 - 120

- Use phosphorus deoxidized copper alloy seamless pipe (C1220T) for refrigeration pipe installation. In addition, make sure there is no damage both inside and outside of the pipe, and no harmful substances such as sulfur, oxide, dust or a contaminant stuck on the pipes.
- Do not use any refrigerant other than the designated refrigerant. Using other refrigerant except the designated refrigerant, may degrade inside refrigeration oil. And air getting into refrigeration circuit may cause over-pressure and resultant it may result in bursting, etc.
- Store the copper pipes indoors and seal the both end of them until they are brazed in order to avoid any dust, dirt or water getting into pipe. Otherwise it will cause degradation of refrigeration oil and compressor breakdown, etc.
- Use special tools for R32 or R410A refrigerant.

Work procedure

- Remove the flare nut and blind flanges on the pipe of the indoor unit.
 - ※ Make sure to loosen the flare nut with holding the nut on pipe side with a spanner and giving torque to the nut with another spanner in order to avoid unexpected stress to the copper pipe, and then remove them. (Gas may come out at this time, but it is not abnormal.)
 - Pay attention whether the flare nut pops out. (as the indoor unit is sometimes pressurized.)
- Make a flare on liquid pipe and gas pipe, and connect the refrigeration pipes on the indoor unit.
 - ※ Bend radius of pipe must be 4D or larger. Once a pipe is bent, do not readjust the bending. Do not twist a pipe or collapse to 2/3D or smaller.
 - Make sure to use flare nuts assembled on the unions. Usage of other flare nuts could cause refrigerant leakage.
 - ※ Do a flare connection as follows:
 - Make sure to hold the nut on indoor unit pipe side using double spanner method as indicated when fastening / loosening flare nuts in order to prevent unintentional twisting of the copper pipe.
 - When fastening the flare nut, align the refrigeration pipe with the center of flare nut, screw the nut for 3-4 times by hand and then tighten it by spanner with the specified torque mentioned in the table above.
- Cover the flare connection part of the indoor unit with attached insulation material after a gas leakage inspection, and tighten both ends with attached straps.
 - Make sure to insulate both gas pipes and liquid pipes completely.
 - ※ Incomplete insulation may cause dew condensation or water dropping.
 - Use heat-resistant (120°C or more) insulations on the gas side pipes.
 - In case of using at high humidity condition, reinforce insulation of refrigerant pipes. Surface of insulation may cause dew condition or water dropping, if insulations are not reinforced.
- Refrigerant is charged in the outdoor unit. For the additional refrigerant charge for the indoor unit and piping, refer to the installation manual attached to the outdoor unit.

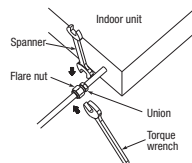

⑤ Refrigerant pipe (continued)

Caution:

Refrigerating machine oil should not be applied to the threads of union or external surface of flare. It is because, even if the same tightening torque is applied, the oil is likely to decrease the slide friction force on the threads and increase, in turn, the axial component force so that it could crack the flare by the stress corrosion. Refrigerating machine oil may be applied to the internal surface of flare only.

<The case of using thickness of insulation is 10mm>

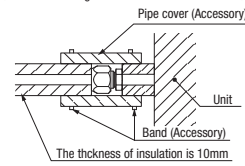

<The case of using reinforced insulation>

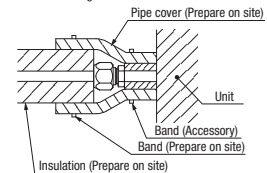

⑥ Drain pipe

Caution

- Install the drain pipe according to the installation manual in order to drain properly. Imperfection in draining may cause flood indoors and wetting the household goods, etc.
- Do not put the drain pipe directly into the ditch where toxic gas such as sulfur, the other harmful and inflammable gas is generated. Toxic gas would flow into the room and it would cause serious damage to user's health and safety (some poisoning or deficiency of oxygen). In addition, it may cause corrosion of heat exchanger and bad smell.
- Connect the pipe securely to avoid water leakage from the joint.
- Insulate the pipe properly to avoid condensation drop.
- Check if the water can flow out properly from both the drain outlet on the indoor unit and the end of the drain pipe after installation.
- Make sure to make descending slope of greater than 1/100 and do not make up-down bend and/or trap in the midway. In addition, do not put air vent on the drain pipe. Check if water is drained out properly from the pipe during commissioning. Also, keep sufficient space for inspection and maintenance.

Work procedure

- Make sure that the drain hose (the soft PVC side) is inserted into the end of the step part of the drain socket. Fix the hose clamp so that its bolt is located on the outside of the indoor unit, and the bolt are fastened in a vertical orientation.
 - Do not apply adhesives on this end.
- Position the hose clamp so that it touches the insulation of the drain hose, and then tighten the bolt.
- Turn the bolt several times until it is securely tightened, but do not tighten it excessively.

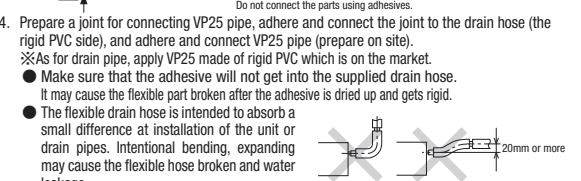
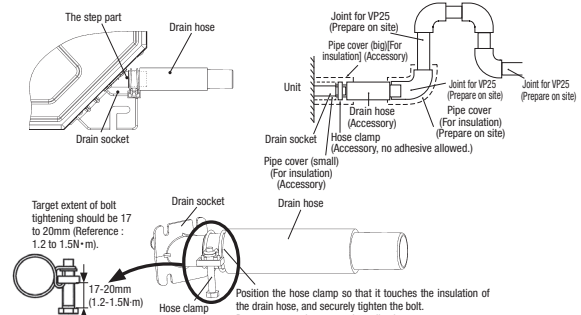

- Prepare a joint for connecting VP25 pipe, adhere and connect the joint to the drain hose (the rigid PVC side), and adhere and connect VP25 pipe (prepare on site).
 - ※ As for drain pipe, apply VP25 made of rigid PVC which is on the market.
 - Make sure that the adhesive will not get into the supplied drain hose. It may cause the flexible part broken after the adhesive is dried up and gets rigid.
 - The flexible drain hose is intended to absorb a small difference at installation of the unit or drain pipes. Intentional bending, expanding may cause the flexible hose broken and water leakage.
 - As for drain pipe, apply VP25 (OD32). If apply PVC25 (OD25), connect the expanded connector to the drain hose, with adhesive. (Multi unit only)

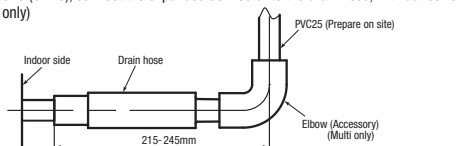

- Make sure to make descending slope of greater than 1/100 and do not make up-down bend and/or trap in the midway.
 - Pay attention not to give stress on the pipe on the indoor unit side, and support and fix the pipe as close place to the unit as possible when connecting the drain pipe.
 - Do not set up air vent.

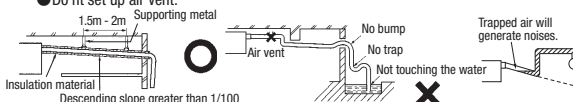

⑥ Drain pipe (continued)

- When sharing a drain pipe for more than 1 unit, lay the main pipe 100mm below the drain outlet of the unit. In addition, select VP30 or bigger size for main drain pipe.

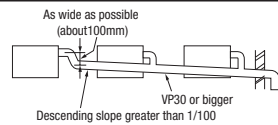

6. Insulate the drain pipe.

- Be sure to insulate the drain socket and rigid PVC pipe installed indoors otherwise it may cause dew condensation and water leakage.
- ※ After drainage test implementation, cover the drain socket part with pipe cover (small size), then use the pipe cover (big size) to cover the pipe cover (small size), clamps and part of the drain hose, and fix and wrap it with tapes to wrap and make joint part gapless.

Drain up

- The position for drain pipe outlet can be raised up to 850mm above the ceiling. Use elbows for installation to avoid obstacles inside ceiling. If the horizontal drain pipe is too long before vertical pipe, the backflow of water will increase when the unit is stopped, and it may cause overflow of water from the drain pan on the indoor unit. In order to avoid overflow, keep the horizontal pipe length and offset of the pipe within the limit shown in the figure below.

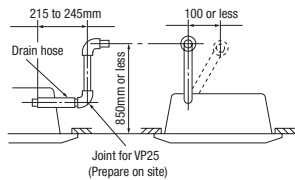

Drain test

- After installing the drain pipe, make sure that drain system works correctly and that no water leaks from the joint and drain pan. Check whether the motor sound of the drain pump is normal.
 - Conduct a drain test when installing, even during the heating season.
 - In the case of new buildings, be sure to complete the test before fixing the ceiling.
1. Pour about 1,000 cc of test water into the drain pan of the indoor unit. Exercise care not to allow electrical equipment such as the drain pump and other components to become wet while filling water. Pour test water through the pouring port of the pipe lid using a feed water pump or a similar device, or through the refrigerant pipe joint.

- In case of pouring water from the air outlet
- In case of pouring water from the pouring port of the pipe lid

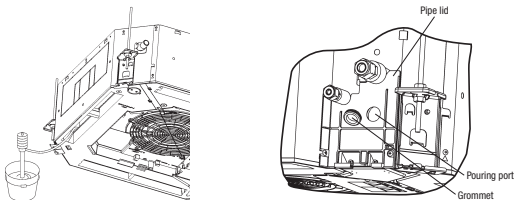

2. Make sure that water drains out completely and that no water leaks from any joints of the drain pipe during the test. Test to confirm that the water drains out correctly while listening to the drain pump motor operating sound. At the drain socket (transparent), it is possible to check whether the water drains out correctly.
3. Unplug the rubber plug on the indoor unit so that the remaining water drains from the drain pan after the draining test. After checking the water drainage, fix the rubber plug correctly. Installation work for the drain pipe must be performed for the entire drain pipe up to the indoor unit. If the pipe lid has been removed in order to pour water, mount the pipe lid again.

Drain pump operation

- In case electrical wiring work completed
Drain pump can be operated by the wired remote control. For the operation method, refer to [Operation for drain pump] in the installation manual for wiring work.
- In case electrical wiring work not completed
Drain pump will run continuously when the dip switch "SW7-1" on the indoor unit PCB is turned ON, the connector CnB is disconnected, and then the power source (230VAC on the terminal block ① and ②) is turned ON. Make sure to turn OFF "SW7-1" and reconnect the connector CnB after the test.

⑦ Wiring-out position and wiring connection

- Electrical installation work must be performed according to the installation manual by an electrical installation service provider qualified by a power provider of the country, and be executed according to the technical standards and other regulations applicable to electrical installation in the country.
- Be sure to use an exclusive circuit.
- Use specified cord, fasten the wiring to the terminal securely, and hold the cord securely in order not to apply unexpected stress on the terminal.
- Do not put both power source line and signal line on the same route. It may cause miscommunication and malfunction.
- Be sure to do D type earth work.
- For the details of electrical wiring work, see attached instruction manual for electrical wiring work.

1. Loosen the 2 screws of the lid of the control box, and slide the lid in the direction of the arrow shown in the figure. It will then be possible to open the lid.
2. Unhook the lid from the control box, and remove the lid.
3. Remove the 2 screws from the wiring cover, and remove the wiring cover.
4. Hold each wire inside the unit, and securely fasten them to the terminal block.
5. Fix the wiring using clamps.
6. Install the wiring cover and the lid of the control box.

Main fuse specification

Specification	Part No.
T3.15A L250V	SSA564A149AF

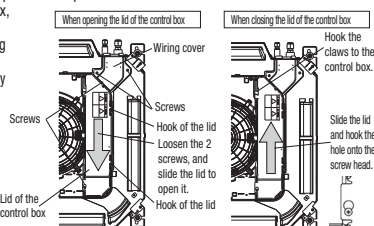

⑦ Wiring-out position and wiring connection (continued)

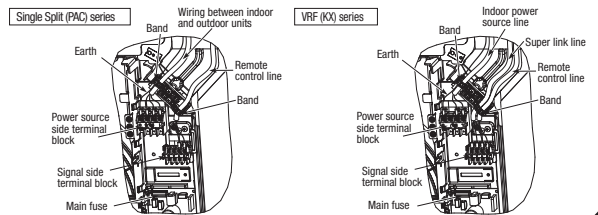

⑧ Panel installation

- Install the panel on the indoor unit after electrical wiring work.
- Refer to the attached manual for panel installation for details.

⑨ Check list after installation

- Check the following items after all installation work completed.

Check if;	Expected trouble	Check
The indoor and outdoor units are fixed securely?	Falling, vibration, noise	
Inspection for leakage is done?	Insufficient capacity	
Insulation work is properly done?	Water leakage	
Water is drained properly?	Water leakage	
Power source voltage is same as mentioned in the model name plate?	PCB burnt out, not working at all	
There is mis-wiring or mis-connection of piping?	PCB burnt out, not working at all	
Earth wiring is connected properly?	Electric shock	
Cable size comply with specified size?	PCB burnt out, not working at all	
Any obstacle blocks airflow on air inlet and outlet?	Insufficient capacity	

⑩ How to check the dirt of drain pan and cleaning the inlet of the drain pump. (Maintenance)

The method of checking the dirt of drain pan

- It is possible to check dirt on the drain pan and drain pump inlet without removing the panel.
1. Open the inlet grille and remove the corner lid on the drain pan side.
 2. Remove the drain cap cover (1 screw) from the panel corner.
 3. Check the dirt on the drain pan from the drain cap, and check the drain pump inlet. If the drain pan is very dirty, remove the drain pan and clean it.
 4. After checking, refix the drain cap cover securely.

- If the cover is not refixed correctly, it may cause condensation to form and/or water to leak.

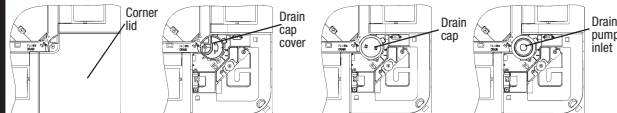

Cleaning of drain pump inlet

- It is possible to clean the drain pump inlet and surrounding area by removing the drain cap only; it is not necessary to remove the panel and drain pan.
 - Before removing the drain cap, remove the rubber plug and drain water from the drain pan.
1. Remove the drain cap cover as described above.
 2. Insert the nose of the pliers into the concave portions (2 places) of the drain cap, and rotate the pliers about 1 turn in the CW direction. The drain cap is removed.
 3. When cleaning the drain pump inlet, use a soft plastic tool. If a metallic tool is used, the drain cap mounting portion may be scratched and water may leak.
 4. Before mounting the drain cap, rinse it and **remove any foreign material from the inside of the cap**. If the drain cap is installed with foreign material inside it, it may cause water to leak.
 5. Insert the nose of the pliers into the concave portions of the drain cap and rotate the pliers to install the drain cap. Rotate the drain cap about 1 turn in the CW direction until it stops rotating. If the drain cap is not rotated for 1 or more turns, the cap will not have been installed correctly. Remove the drain cap, and then install it again correctly.
 6. After tightening the drain cap, make sure the triangle (Δ) mark of the drain cap comes close to the triangle mark on the panel. If these triangle marks are not close to each other, tighten the drain cap further.
 7. Refix the drain cap cover and rubber plug securely. If the cover is not refixed correctly, it may cause condensation to form and/or water to leak.

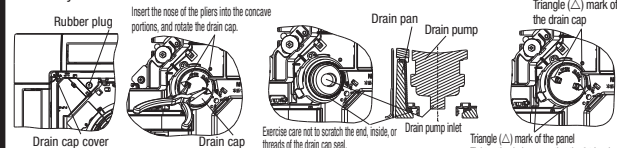

Notes for removing the drain pan

- Before removing the drain pan, drain water from the drain pan. Remove the rubber plug and drain water.
- The drain pan is installed by the temporary installation plate. Remove the 2 drain pan fixing screws, and loosen the 2 screws of the temporary installation plate. Slide the temporary installation plate to the outside of the drain pan. And then, it is possible to remove the drain pan.
- When reinstalling the drain pan, slide the temporary installation plate to the inside and temporarily fix the drain pan. Then, tighten the 2 drain pan fixing screws and the 2 screws of the temporary installation plate. Also, refix the rubber plug securely.

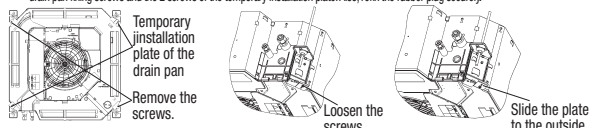

4. INSTALLATION OF PANEL

PJF012D037

Read this manual together with the indoor unit's installation manual.

⚠ WARNING

- Fasten the wiring to the terminal securely and hold the cable securely so as not to apply unexpected stress on the terminal. **Loose connection or hold will cause abnormal heat generation or fire.**
- Make sure the power source is turned off when electric wiring work. **Otherwise, electric shock, malfunction and improper running may occur.**

Function

The Anti draft panel has the anti draft mechanism. If the Anti draft panel is installed and the anti draft function is set, the anti draft function will be operated and reduce the draft feeling. (Refer to **⑥ Panel setting** for details.)

- Standard panel : without the anti draft mechanism
- Anti draft panel : with the anti draft mechanism

① Before installation

- Follow installation manual carefully, and install the panel properly.
- Check the following items.
- Accessories

Accessories		
Bolt		4 pieces For panel installation
Strap		4 pieces For avoiding the corner panel from falling
Screw		4 pieces For fixing the corner panel

Note: Accessories are laid in the position removing the corner lid.

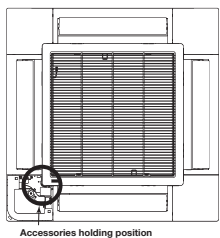

② Checking the indoor unit installation position

- Read this manual together with the air-conditioner installation manual carefully.
- Check if the opening size for the indoor unit is correct with the level gauge supplied in the indoor unit.
- Check if the gap between the plane and the indoor unit is correct by inserting the level gauge into the air outlet port of the indoor unit. (See below drawing)
- Adjust the installation elevation if necessary.
- Remove the level gauge before installing the panel.

Caution

If there is a height difference beyond the design limit between the installation level of the indoor unit and the panel, the panel may be subject to excessive stress during installation and it may cause distortion and damage.

The installation level of the indoor unit can be adjusted finely from the opening provided on the corner, even after panel is installed. (Refer to **④ Removing the corner lid** for details.)

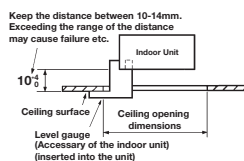

③ Removing the inlet grille

- Hold the stoppers on the inlet grille (2 places) toward OPEN direction, open the inlet grille.
- Remove the hooks of the inlet grille from the panel while it is in the open position.

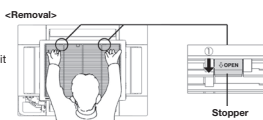

④ Removing the corner lid

- Pull the corner lid toward the direction indicated by the arrow and remove it. (Same way for all 4 corner lids)

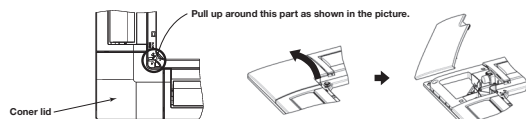

⑤ Orientation of the panel installation

- Take note that there is an orientation to install the panel.
- Install the panel with the orientation shown on the right.
- Align the "PIPE SIDE" mark (on the panel) with the refrigerant pipes on the indoor unit.
- Align the "DRAIN" mark (on the panel) with the drain pipe on the indoor unit.

CAUTION

In case the orientation of the panel is not correct, it will lead to air leakage and also it is not possible to connect the flap motor wiring.

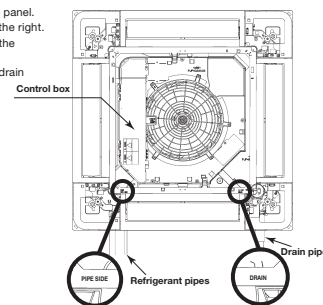

⑥ Installing the panel

- Temporary hanging
 - Lift up the hanger (2 places) on the panel for temporary support.
 - Hang the panel on the hook on the indoor unit.

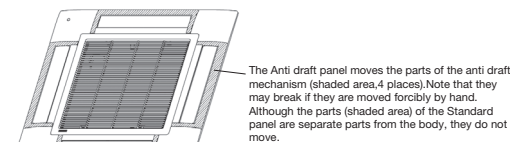
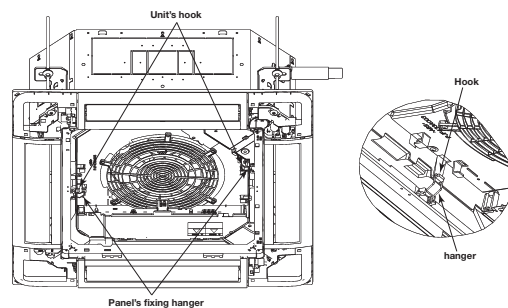

Caution

The parts (shaded area), of the anti draft mechanism around the air outlet, are separate parts. Handle the panel with care. Especially, the shaded area of the Anti draft panel move. Note that they may break if they are moved forcibly by hand.

- Fix the panel on the indoor unit
 - Fasten the panel on the indoor unit with the 4 bolts supplied with the panel.

Caution

- Improperly tightened fixing bolts cause the problems listed below, so make sure that bolts are securely tightened.
- If there is a gap between the ceiling and the panel even after the fixing bolts are tightened, adjust the installation level of the indoor unit again.

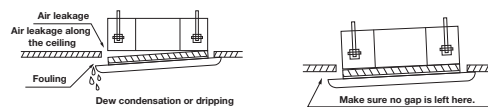

- It is possible to adjust the installation height of the indoor unit with the panel installed as long as there is no influence on the drain pipe inclination and/or the indoor unit levelness.

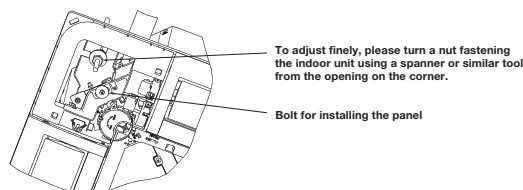

Caution

Do not give any stress on the panel when adjusting the height of the indoor unit to avoid unexpected distortion. It may cause the distortion of panel or failing to close the inlet grille, and the parts of the anti draft mechanism.

⑦ Electrical wiring

The wiring work varies depending on the panel type. Select the wiring work appropriate for the panel type. The connection positions of the indoor unit are as shown below irrespective of the panel type.

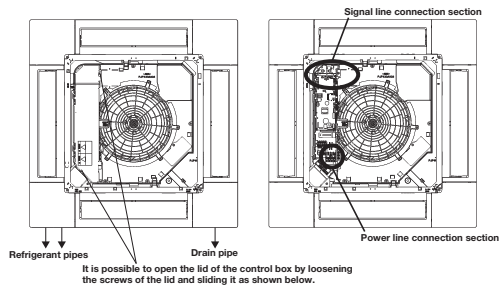

<For the Standard panel>

1. Loosen 2 screws on the control box lid of the indoor unit, and remove the lid by sliding it.
2. Pass the flap motor wiring (20-wire) through the hook of the control box, and connect to CnJ1 (20P, white).
3. Fix the control box lid of the indoor unit, and tighten 2 screws.

For the Standard panel
Signal line connection section

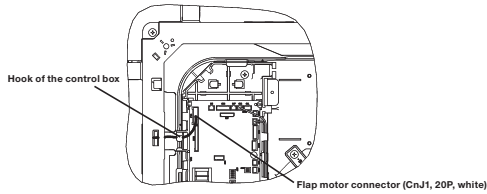

<For the Anti draft panel>

1. Loosen 2 screws on the control box lid of the indoor unit, and remove the lid by sliding it.
2. Pass the flap motor cable (20-wire) through the hook of the control box, and connect to CnJ1 (20P, white).
3. Pass the anti draft motor cable (20-wire) through the hook of the control box, and connect to CnJ2 (20P, white).
4. Fix the control box lid of the indoor unit, and tighten the 2 screws.

For the Anti draft panel
Signal line connection section

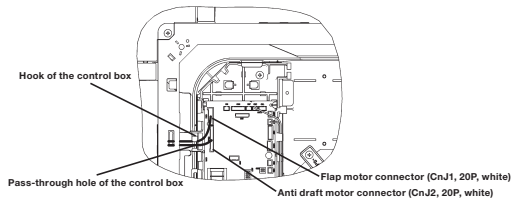

⑧ Installing a corner lid

1. To avoid unexpected falling of the corner lid, put the strap onto the corner lid's pin with turning the strap up.
2. Then hang the strap of a corner lid onto the panel's pin.
3. First insert the part "a" of a corner lid into the part "A" of the panel, and then engage 2 hooks.
4. Fix with screw.

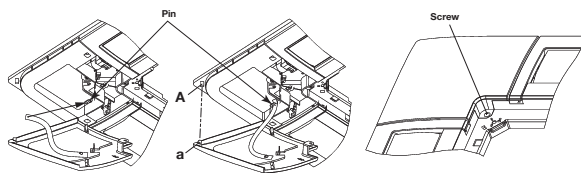

⑨ Installing the inlet grille

To attach the inlet grille, follow the procedure described in ⑧ **Removing the inlet grille** in the reverse order.

1. Hang the hooks of the inlet grille in the hole of the panel. (The hooks of the grille can be hanged in 4 side of the panel as following.)
2. After the grille is hanged, close the grille while the stoppers(2 places) on the grille are kept pressed to "OPEN" direction. When the grille comes to the original position, release the stoppers to hold the grille. Make sure to hear the sound of "CLICK" in both stoppers.

<Installation>

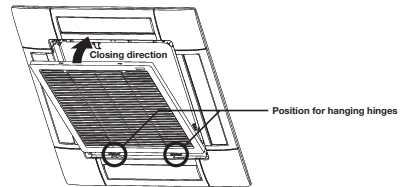

Caution

- Installing the inlet grille from the hinge side.
- Be careful in the inlet grille installing, unstable installing may cause grille falling.
- Repair or replace the distorted, broken stopper at once, or the grille falling may occur.

⑩ Panel setting

<Flap swing range setting (Individual flap control setting)>

It is possible to change the swing range of the flap by the wired remote control. Once the upper and lower limit positions are set, the flap will swing within the set range. It is also possible to set the different range to each flap.

<Anti draft setting>

The anti draft function will not be operated if the anti draft panel is installed and its wirings are only connected. To operate the anti draft function, enable the anti draft setting by using the wired or wireless remote control.

Note: It is not possible to set by the following remote control models or older.

Wired: RC-EX1A, RC-E5, RCH-E3
Wireless: RCN-E1R

Once you have enabled the settings in this mode, the anti draft function is operated when the air-conditioner is started, and the parts of the anti draft mechanism are always open when the air-conditioner is operating. When the air-conditioner is stopped, they are closed. It is possible to enable or disabled the anti draft function for each air outlet.

For the setting details, refer to the user's manual supplied with the remote control.

5. WIRELESS KIT

FDT series(RCN-T-5BW-E2, RCN-T-5BB-E2)

(1) Specification

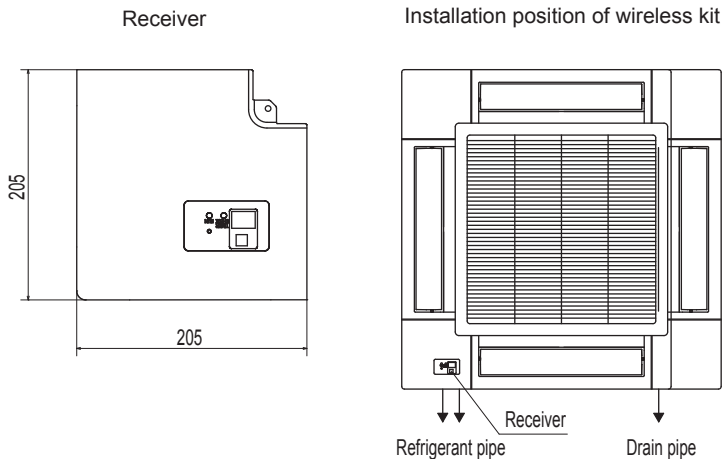

Installation of wireless kit

Do not install the wireless kit at the following places in order to avoid malfunction.

- (1) Places exposed to direct sunlight
- (2) Places near heat devices
- (3) High humidity places
- (4) Hot surface or cold surface enough to generate condensation
- (5) Places exposed to oil mist or steam directly
- (6) Uneven surface
- (7) Places affected by the direct airflow of the AC unit
- (8) Places where the receiver is influenced by the fluorescent lamp(especially inverter type) or sunlight
- (9) Places where the receiver is affected by infrared rays of any other communication devices
- (10) Places where some object may obstruct the communication with the remote control

Setting switch on PCB of receiver

SW1	Prevent interference during plural setting	ON:Normal OFF:Remote
SW2	Receiver master/slave setting	ON:Master OFF:Slave
SW3	Buzzer	ON:Valid OFF:Invalid
SW4	Auto restart	ON:Valid OFF:Invalid

Default setting: mark

Notes

- (1) Receiver can install the position as shown.
- (2) Two LR03 AAA dry cell batteries for remote control are enclosed.
- (3) See spec sheet of "Wireless remote control" about remote control.

Remote control

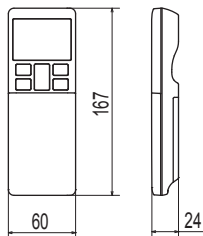

Remote control holder

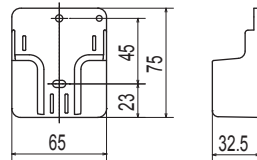

Wireless remote control's operable area

- ① Standard reachable area of the signal
[condition] Illuminance at the receiver:300lux
(When no lighting is installed within 1m of the receiver in an ordinary office.)

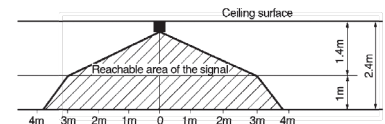

- ② Correlation between illuminance at the receiver and reachable area of the signal in a plain view.
The drawing in the right shows the correlation between the reachable area of the signal and illuminance at the receiver when the remote control is operated at 1m high under the condition of ceiling height of 2.4m.
When the illuminance becomes double, the area is narrowed down to two thirds.

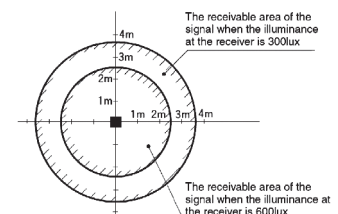

- ③ Installation tips when several receivers are installed close
Minimum distance between the indoor units which can avoid cross communication is 5m under the condition of 300lux of illuminance at the receiver.
(When no lighting is installed within 1m of the receiver in an ordinary office.)

Unit:mm

PJF000Z632

(2) Installation manual

Notes:

1. Following function of FDT indoor unit series are not able to be set with this wireless remote control.
 - Individual flap control system
2. This wireless remote control can operate the prevention function without connecting the wired remote control.

PJF012D035C













Safety precautions

- Please read this manual carefully before starting installation work to install the unit properly. Every one of the followings is important information to be observed strictly.
- ⚠ **WARNING** Failure to follow these instructions properly may result in serious consequences such as death, severe injury, etc.
- ⚠ **CAUTION** Failure to follow these instructions properly may cause injury or property damage. It could have serious consequences depending on the circumstances.
- The following pictograms are used in the text.





	Never do.		Always follow the instructions given.
---	-----------	---	---------------------------------------

- Keep this manual at a safe place where you can consult with whenever necessary. Show this manual to installers when moving or repairing the unit. When the ownership of the unit is transferred, this manual should be given to a new owner.

⚠ WARNING

-  • **Consult your dealer or a professional contractor to install the unit.**
Improper installation made on your own may cause electric shocks, fire or dropping of the unit.
-  • **Installation work should be performed properly according to this installation manual.**
Improper installation work may result in electric shocks, fire or break-down.
-  • **Be sure to use accessories and specified parts for installation work.**
Use of unspecified parts may result in drop, fire or electric shocks.
-  • **Install the unit properly to a place with sufficient strength to hold the weight.**
If the place is not strong enough, the unit may drop and cause injury.
-  • **Be sure to have the electrical wiring work done by qualified electrical installer, and use exclusive circuit.**
Power source with insufficient and improper work can cause electric shock and fire.
-  • **Shut OFF the main power source before starting electrical work.**
Otherwise, it could result in electric shocks, break-down or malfunction.
-  • **Do not modify the unit.**
It could cause electric shocks, fire, or break-down.
-  • **Be sure to turn OFF the power circuit breaker before repairing/inspecting the unit.**
Repairing/inspecting the unit with the power circuit breaker turned ON could cause electric shocks or injury.
-  • **Do not install the unit in appropriate environment or where inflammable gas could generate, flow in, accumulate or leak.**
If the unit is used at places where air contains dense oil mist, steam, organic solvent vapor, corrosive gas (ammonium, sulfuric compound, acid, etc) or where acidic or alkaline solution, special spray, etc. are used, it could cause electric shocks, break-down, smoke or fire as a result of significant deterioration of its performance or corrosion.
-  • **Do not install the unit where water vapor is generated excessively or condensation occurs.**
It could cause electric shocks, fire, or break-down.
-  • **Do not use the unit in a place where it gets wet, such as laundry room.**
It could cause electric shocks, fire, or break-down.
-  • **Do not operate the unit with wet hands.**
It could cause electric shocks.

⚠ WARNING

- 
 - **Do not wash the unit with water.**
It could cause electric shocks, fire, or break-down.
- 
 - **Use the specified cables for wiring, and connect them securely with care to protect electronic parts from external forces.**
Improper connections or fixing could cause heat generation, fire, etc.
- 
 - **When installing the unit at a hospital, telecommunication facility, etc., take measures to suppress electric noises.**
It could cause malfunction or break-down due to hazardous effects on the inverter, private power generator, high frequency medical equipment, radio communication equipment, etc. The influences transmitted from the remote control to medical or communication equipment could disrupt medical activities, video broadcasting or cause noise interference.
- 
 - **Do not leave the remote control with its PCB case removed.**
If dew, water, insect, etc. enters through the hole, it could cause electric shocks, fire or break-down.







⚠ CAUTION

- 
 - Do not install the wireless kit at the following places in order to avoid malfunction. It could cause break-down or deformation of remote control.

<ul style="list-style-type: none"> (1) Places exposed to direct sunlight (2) Places near heat devices (3) High humidity places (4) Hot surface or cold surface enough to generate condensation (5) Places exposed to oil mist or steam directly (6) Uneven surface (7) Places affected by the direct air flow of the AC unit 	<ul style="list-style-type: none"> (8) Places where the receiver is influenced by the fluorescent lamp (especially inverter type) or sunlight (9) Places where the receiver is affected by infrared rays of any other communication devices (10) Places where some object may obstruct the communication with the remote control
---	---

① Accessories

Please make sure that you have all of the following accessories.

① Receiver		1	→	① Wireless remote control (RCN-E2)		1
② Parts set (A)		1		② Remote control holder		1
③ Installation manual		1		③ Screw for holder		2
			④ AAA dry cell battery (LR03)		2	
			⑤ User's manual		1	

② Preparation before installation

Setting on site

PCB on the receiver has the following switches to set the function.
Default setting is shown with mark.

SW1	Prevents interference during plural setting	<input type="checkbox"/> ON : Normal	OFF : Customized
SW2	Receiver master/slave setting	<input type="checkbox"/> ON : Master	OFF : Slave
SW3	Buzzer	<input type="checkbox"/> ON : Valid	OFF : Invalid
SW4	Auto restart	ON : Valid	<input type="checkbox"/> OFF : Invalid

② Preparation before installation (continued)

To change setting

1. Remove the cover by unscrewing two screws from the back of receiver.
2. Change the setting by the switch on PCB.

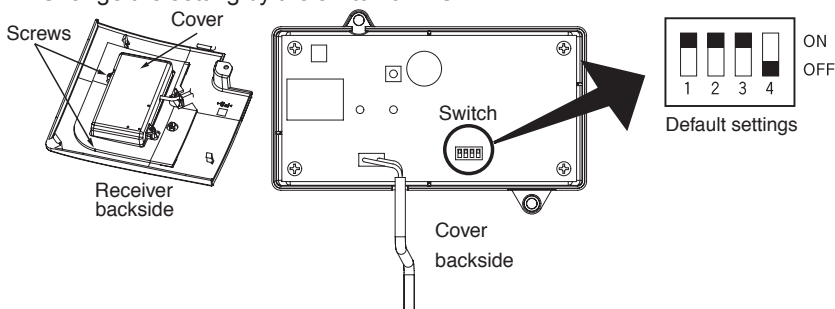

Master/Slave setting when using plural remote controls

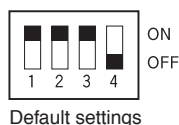

Up to two receiver or wired remote control can be installed in one indoor unit group.
When two receiver or wired remote control are used, it is necessary to change SW on the PCB to set it as slave.

3. When SW1 is turned to OFF position, change the wireless remote control setting.
For the method of changing the setting, refer to [Setting to avoid mixed communication](#) of

④ Wireless remote control

*The receivable area of the signal refer to [⑤ Receiver](#).

③ How to install the receiver

The receiver can be installed by replacing with a corner panel on the applicable decorative panel.

Preparation before installation

- ① Attach the decorative panel onto the air-conditioner according to the installation manual for the panel.
- ② Remove the air return grille.
- ③ Remove a corner panel located on the refrigerant pipes side.
- ④ Remove three screws and detach the cover (indicated as shadowed area) from the control box of the air-conditioner.

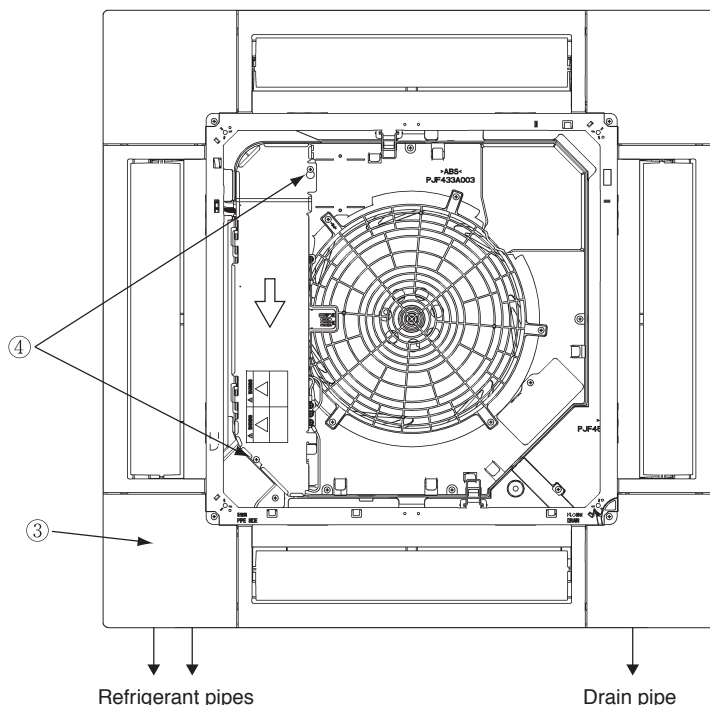

③ How to install the receiver(continued)

Installation of the receiver

- ① Loosen the bolts which fix the panel and make a gap between the panel and the indoor unit.
- ② Put the wiring of the receiver through the opening.
- ③ Put the wiring on the notch on the control box so as not to be pinched by the control box and lid as shown below.
- ④ Connect the wiring to the terminal block provided in the control box. (No polarity)
- ⑤ Attach the receiver to the panel according to the panel installation manual.
- ⑥ Fix the wiring with the clamp so that the wiring do not contact the edge of control box's metal sheet.
- ⑦ Reattach the control box lid with 3 screws removed.

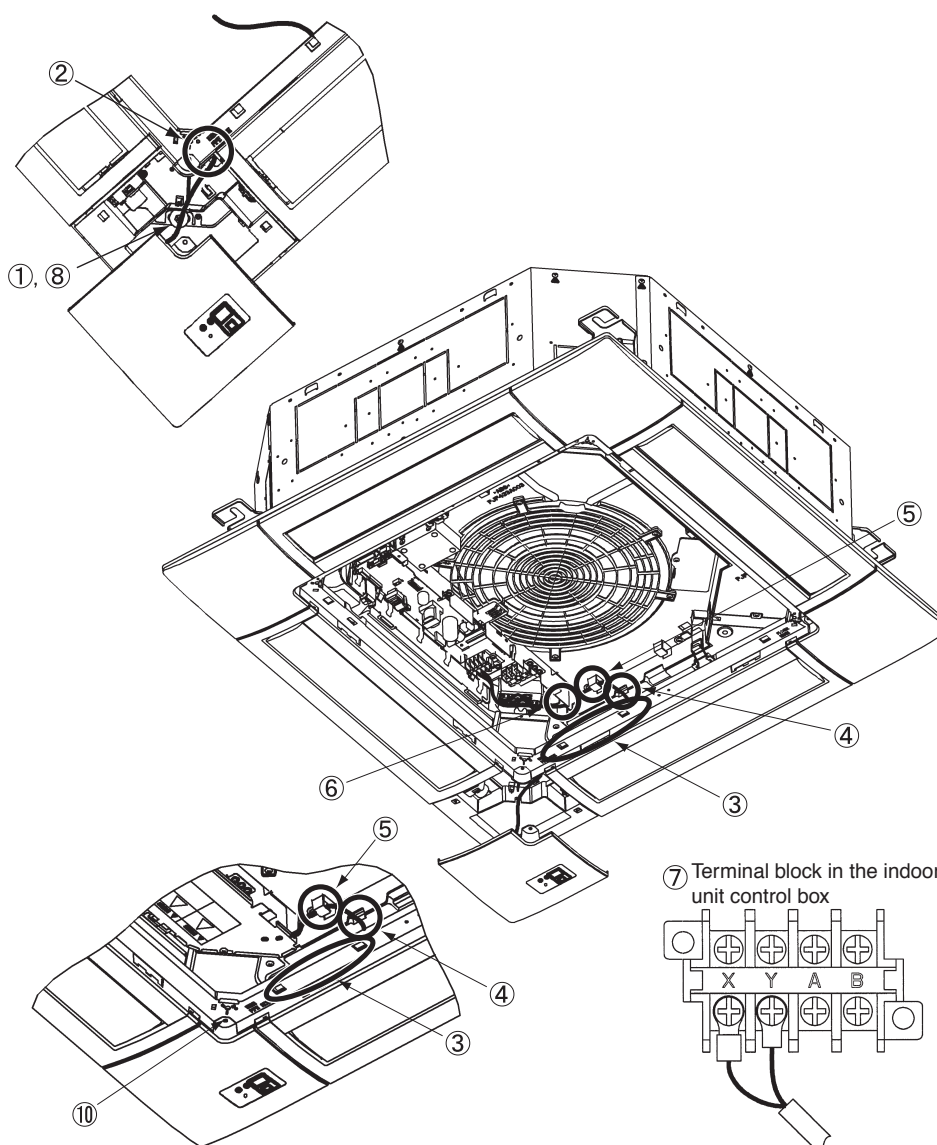

4 Wireless remote control

Installation tips for the remote control holder

Fix the remote control holder using the screws supplied with this product.

* Precautions for installing the holder

- Adjust the position so that it is upright.
- Ensure that the screw heads are not protruding.
- Do not attach the holder on plaster wall

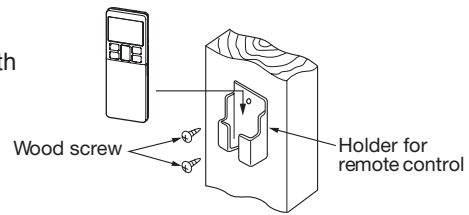

How to insert batteries

1. Detach the back lid.
2. Insert the batteries. (two AAA batteries)
3. Reattach the back lid.

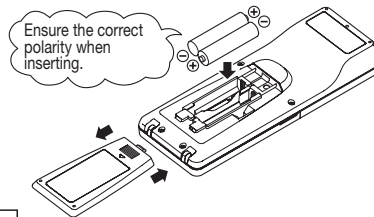

Setting to avoid mixed communication

1. Detach the back lid, and remove the batteries.
2. Cut off the switching wire in the battery compartment using nippers.
3. Insert the batteries, and attach the back lid.

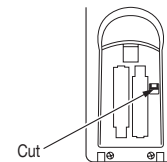

Changing the remote control setting

How to change the Auto Run setting

The Auto Run mode is not available on the building air-conditioning and gas heat pump series (excluding the cooling/heating free multi system).

When using the remote control to operate those models, set the remote control to disable the Auto Run mode.

To disable the Auto Run mode, press the **ACL** switch while holding down the **MODE** button, or insert batteries while holding down the **MODE** button.

* Note: Once the batteries are removed, the setting is reset to the factory default. When the batteries are removed, repeat the steps described above.

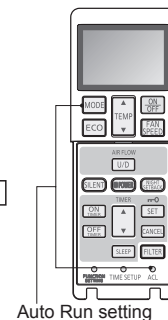

Auto Run setting

Indoor function settings

1. How to set indoor functions

- ① Press the ON/OFF button to stop the unit.
- ② Press the desired one of the buttons shown item 2. while holding down the FUNCTION SETTING switch.
- ③ Use the selection buttons, ▲ and ▼, to change the setting.
- ④ Press the SET button.

The buzzer on the remote control signal receiver beeps twice, and the LED lamp flashes four times at two-second intervals.

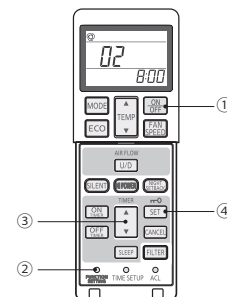

④ Wireless remote control (continued)

2. Setting details

The following functions can be set.

Button	Number indicator	Function setting
FAN SPEED	00	Fan speed setting : Standard
	01	Fan speed setting : Setting 1 *
	02	Fan speed setting : Setting 2 *
MODE	00	Room heating temperature adjustment : Disable
	01	Room heating temperature adjustment : +1°C
	02	Room heating temperature adjustment : +2°C
	03	Room heating temperature adjustment : +3°C
FILTER	00	Filter sign display : OFF
	01	Filter sign display : 180 hours
	02	Filter sign display : 600 hours
	03	Filter sign display : 1000 hours
	04	Filter sign display : Operation stop after 1000 hours have elapsed
U/D (Up/Down)	00	Anti draft setting : Disable
	01	Anti draft setting : Enable
SILENT	00	Infrared sensor setting (Motion sensor setting) : Disable
	01	Infrared sensor setting (Motion sensor setting) : Enable
HI POWER	00	Infrared sensor control (Motion sensor control) : Disable
	01	Infrared sensor control (Motion sensor control) : Power control only
	02	Infrared sensor control (Motion sensor control) : Auto OFF only
	03	Infrared sensor control (Motion sensor control) : Power control and Auto OFF
ON TIMER	00	Cooling fan residual-period running : Disable
	01	Cooling fan residual-period running : 0.5 hours
	02	Cooling fan residual-period running : 2 hours
	03	Cooling fan residual-period running : 6 hours
OFF TIMER	00	Heating fan residual-period running : Disable
	01	Heating fan residual-period running : 0.5 hours
	02	Heating fan residual-period running : 2 hours
	03	Heating fan residual-period running : 6 hours
NIGHT SETBACK	00	Remote control signal receiver LED : Brightness High
	01	Remote control signal receiver LED : Brightness Low
	02	Remote control signal receiver LED : OFF

* Refer to service manual.

5 Receiver

1 Control plural indoor units with one remote control

Up to 16 indoor units can be connected.

1. Connect the XY terminal with 2 cores wire. As for the size, refer to the following note.
2. For Packaged air-conditioner series, set the indoor unit address with SW2 on the indoor unit PCB from [0] to [F] so as not to duplicate.

Restrictions on the thickness and length of wire (Maximun total extension 600m.)

Standard	Within	0.3 mm ² × 100m
	Within	0.5 mm ² × 200m
	Within	0.75mm ² × 300m
	Within	1.25mm ² × 400m
	Within	2.0 mm ² × 600m

For the shop series

For VRF series, set the indoor unit address with SW1, SW2 and SW5-2 on the indoor unit PCB from [000] to [127] so as not to duplicate.

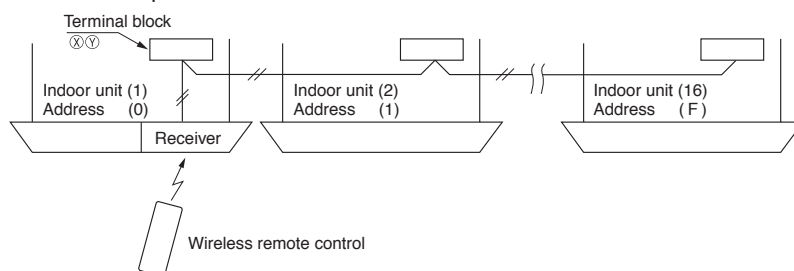

For the building air-conditioning and gas heat pump series

Set the indoor unit and outdoor unit numbers by manually specifying the addresses. Use the rotary switches SW1 and SW2 provided on the indoor unit PCB (printed circuit board) to set the indoor unit numbers so that they are not duplicated.

Master/Slave setting when using plural remote control

Up to two receivers can be installed in one indoor unit group.

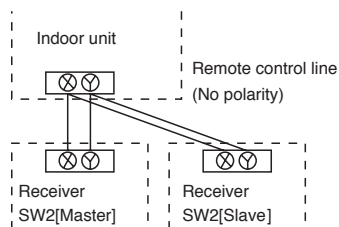

Switch	Setting	Function
SW2	ON	Master
	OFF	Slave

Wireless remote control's operable area

1. Standard reachable area of the signal
[condition] Illuminance at the receiver: 300lux
(when no lighting is installed within 1m of the receiver in an ordinary office.)

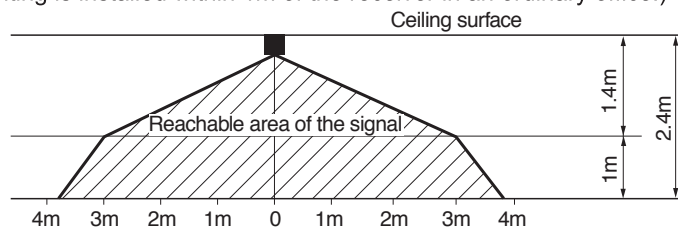

⑤ Receiver (continued)

2. Correlation between illuminance at the receiver and reachable area of the signal in a plain view. The drawing in the right shows the correlation between the reachable area of the signal and illuminance at the receiver when the remote control is operated at 1.0m high under the condition of ceiling height of 2.4m. When the illuminance becomes double, the area is narrowed down to two thirds.

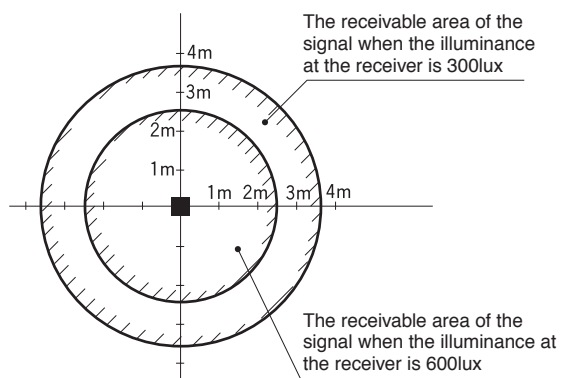

3. Installation tips when several receivers are installed close
 Minimum distance between the indoor units which can avoid cross communication is 5m under the condition of 300lux of illuminance at the receiver.
 (When no lighting is installed within 1m of the receiver in an ordinary office)

Backup switch

A backup switch is provided on the receiver. Even when the operation from the wireless remote control is not possible (due to flat batteries, control lost, or control failure), still it possible to operate as temporary means. Press the switch directly when operating it.

1. The air-conditioner starts the operation with the condition of Auto mode, 23°C of set point, High fan speed and horizontal louver position.
2. The air-conditioner stops the operation when the switch is pressed when in operation.

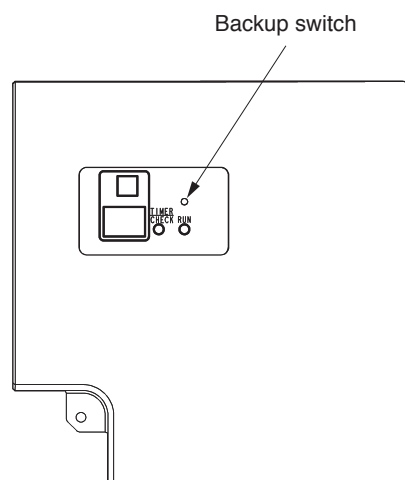

Cooling test run operation

- After safety confirmation, turn on the power.
- Transmit a cooling operation command with the wireless remote control unit, while the backup switch on the receiver is depressed.
- If the backup switch on the receiver is pressed during a test run, it will end the test run.
- If you cannot operate the unit properly during a test run, please check wiring by consulting with inspection guides.

How to read the 2-digit display

On the receiver of a wireless kit, a two-digit (7-segment) display is provided.

1. An indication will be displayed for one hour after power on.
2. An indication will be displayed for 3.5 seconds after transmitting a "STOP" command from the wireless remote control or the operation of the backup switch to stop the unit.
3. An indication appearing in (1) or (2) above will go off as soon as the unit starts operation.
4. When there are no error records to indicate, addresses of all the connected units are displayed.
5. When there are some error records remaining, the error records are displayed.
6. Error records can be cleared by transmitting a "STOP" command from the wireless remote control, while the backup button is pressed.

6. MOTION SENSOR KIT

FDT series(LB-T-5BW-E, LB-T-5BB-E)

(1) Specification

Motion sensor kit

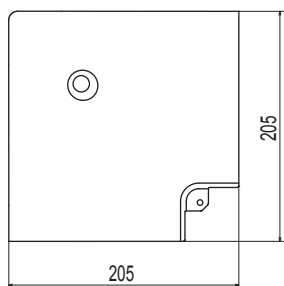

Installation position of motion sensor kit

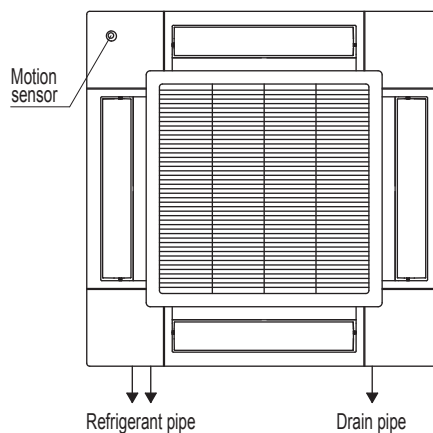

Note

- (1) Motion sensor must be installed to the position as shown.

Unit:mm

Installation of motion sensor kit

Do not install the motion sensor kit at the following places in order to avoid malfunction.

- (1) Places exposed to direct sunlight
- (2) Places near heat devices
- (3) High humidity places
- (4) Hot surface or cold surface enough to generate condensation
- (5) Places exposed to oil mist or steam directly
- (6) Places affected by the direct airflow of the indoor unit
- (7) Places where the motion sensor is influenced by the fluorescent lamp or sunlight
- (8) Places where the motion sensor is affected by infrared rays of any other communication devices
- (9) Places where some object may obstruct the motion sensor

Standard detectable area

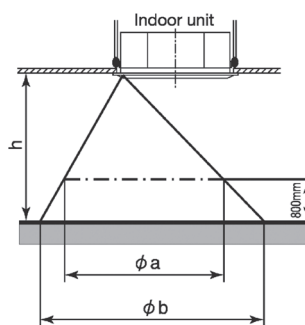



Height of the ceiling	h[m]	2.7	3.5	4.0
Detectable area	ϕa [m]	about 4.5	about 6.4	about 7.6
	ϕb [m]	about 6.4	about 8.3	about 9.5

(2) Installation manual

PJF012D036 

 **WARNING**

- Connect the wiring to the PCB in the control box on the indoor unit and hold the wiring securely so as not to apply unexpected stress on the PCB. Loose connection or hold will cause abnormal heat generation or fire. 
- Make sure the power source is turned off when electric wiring work. Otherwise, electric shock, malfunction and improper running may occur. 

 **CAUTION**

- Do not install the motion sensor kit at the following places in order to avoid malfunction.

<ul style="list-style-type: none"> (1) Places exposed to direct sunlight (2) Places near heat devices (3) High humidity places (4) Hot surface or cold surface enough to generate condensation (5) Places exposed to oil mist or steam directly (6) Places affected by the direct air flow of the Indoor unit 	<ul style="list-style-type: none"> (7) Places where the motion sensor is influenced by the fluorescent lamp or sunlight (8) Places where the motion sensor is affected by infrared rays of any other communication devices (9) Places where some object may obstruct the motion sensor
---	---
- Do not leave the motion sensor without the cover. In case the cover needs to be detached, protect the motion sensor with a packaging or bag. In order to keep it away from water and dust. 

Attention

- Instruct the customer how to operate it correctly referring to the instruction manual.
- For the installation method of the air-conditioner itself, refer to the installation manual enclosed in the package.

① Accessories

Please make sure that you have the motion sensor.

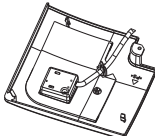
Motion sensor		1
---------------	---	---

② Installing the motion sensor

It is possible to install the motion sensor by replacing with a corner lid on the panel.

Aim of the detectable scope

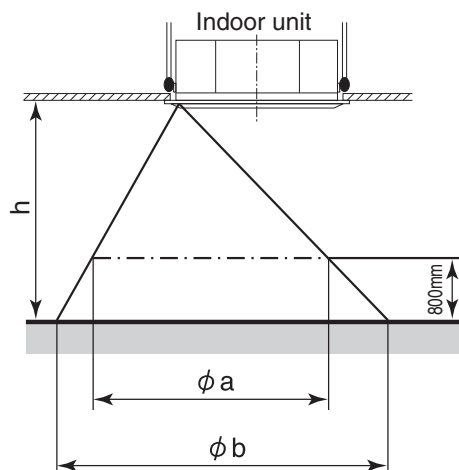

Hight of the ceiling	h[m]	2.7	3.5	4.0
Detectable scope①	φ a[m]	about 4.5	about 6.4	about 7.6
Detectable scope②	φ b[m]	about 6.4	about 8.3	about 9.5

Preparation before installation

- ① Install the panel onto the indoor unit according to the installation manual for the panel.
- ② Remove the inlet grille.
- ③ Remove the corner lid (A) located on the panel.
- ④ Loosen 2 screws for the control lid. (It is unnecessary to remove the screws.)
- ⑤ Slide the control lid, and open and remove it.

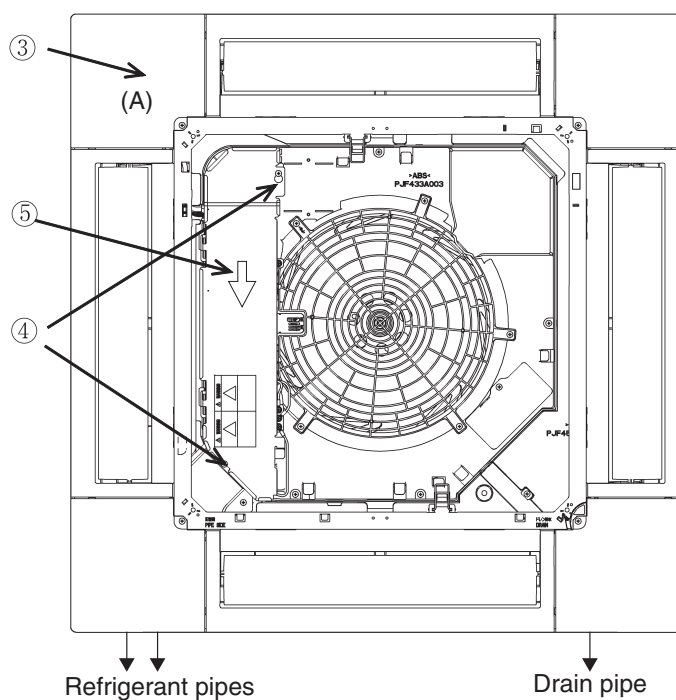

Installation of the motion sensor

- ① Loosen the bolts which fix the panel, and make a gap between the panel and the indoor unit.
- ② Pass the wiring of the motion sensor through the opening of the panel.
- ③ Hang the wiring on the hook which is on the panel's inside.
- ④ Pass the wiring through the opening of the control box.
- ⑤ Connect the connector to CNL(3P,Black) on PWB in the control box.
- ⑥ Tighten the bolts which fix the panel.
- ⑦ Install the motion sensor on the panel.
- ⑧ Fix the motion sensor by the screw.
- ⑨ Reinstall the control lid, and tighten 2 screws.

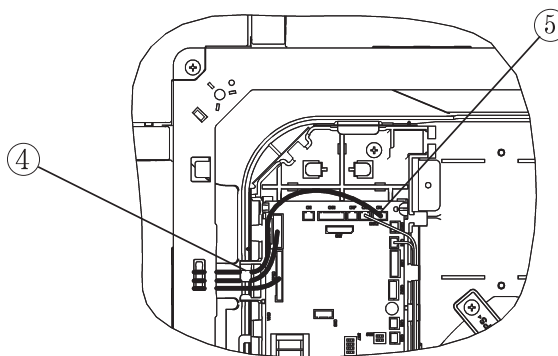
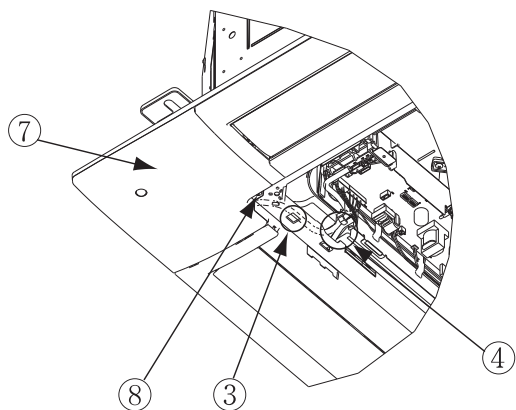
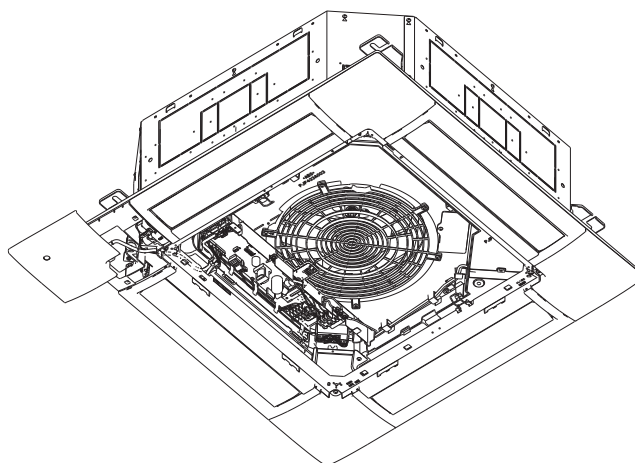
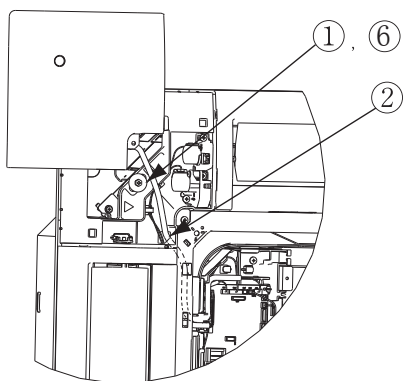

③ Setting the motion sensor

The motion sensor will not function if it is only installed.

Set the function of the motion sensor by the wired or wireless remote control.

Refer to the manual instruction of each remote control for the setting procedure.

Note: It is not possible to set by the following remote control models or older.

Wired: RC-EX1A, RC-E5, RCH-E3

Wireless: RCN-E1R

CEILING CASSETTE-4 WAY COMPACT TYPE (FDTC series)

CONTENTS

1. EXTERIOR DIMENSIONS	33
2. ELECTRICAL WIRING	37
3. INSTALLATION OF INDOOR UNIT	39
4. INSTALLATION OF PANEL	43
5. WIRELESS KIT	47
6. MOTION SENSOR KIT	56

1. EXTERIOR DIMENSIONS

Ceiling cassette-4 way compact type (FDTC)

Models FDTC25VG, 35VG, 40VG, 50VG, 60VG

FDTC25VH, 35VH, 40VH, 50VH, 60VH

(1) Grid type

Symbol	Model	Content
A	Gas piping	25.35 φ9.52 (3/8") (Flare) φ12.7 (1/2") (Flare)
B	Liquid piping	φ6.35 (1/4") (Flare)
C	Drain piping	VP25 (O.D.32)
D1	Power source connection	
D2	Remote control code and signal wiring connection	
F	Suspension bolts	(M10 or M8)
G	Outside air opening for ducting	(Knock out)
H	Air outlet opening for ducting	φ125 (Knock out)
J	Inspection opening	450x450

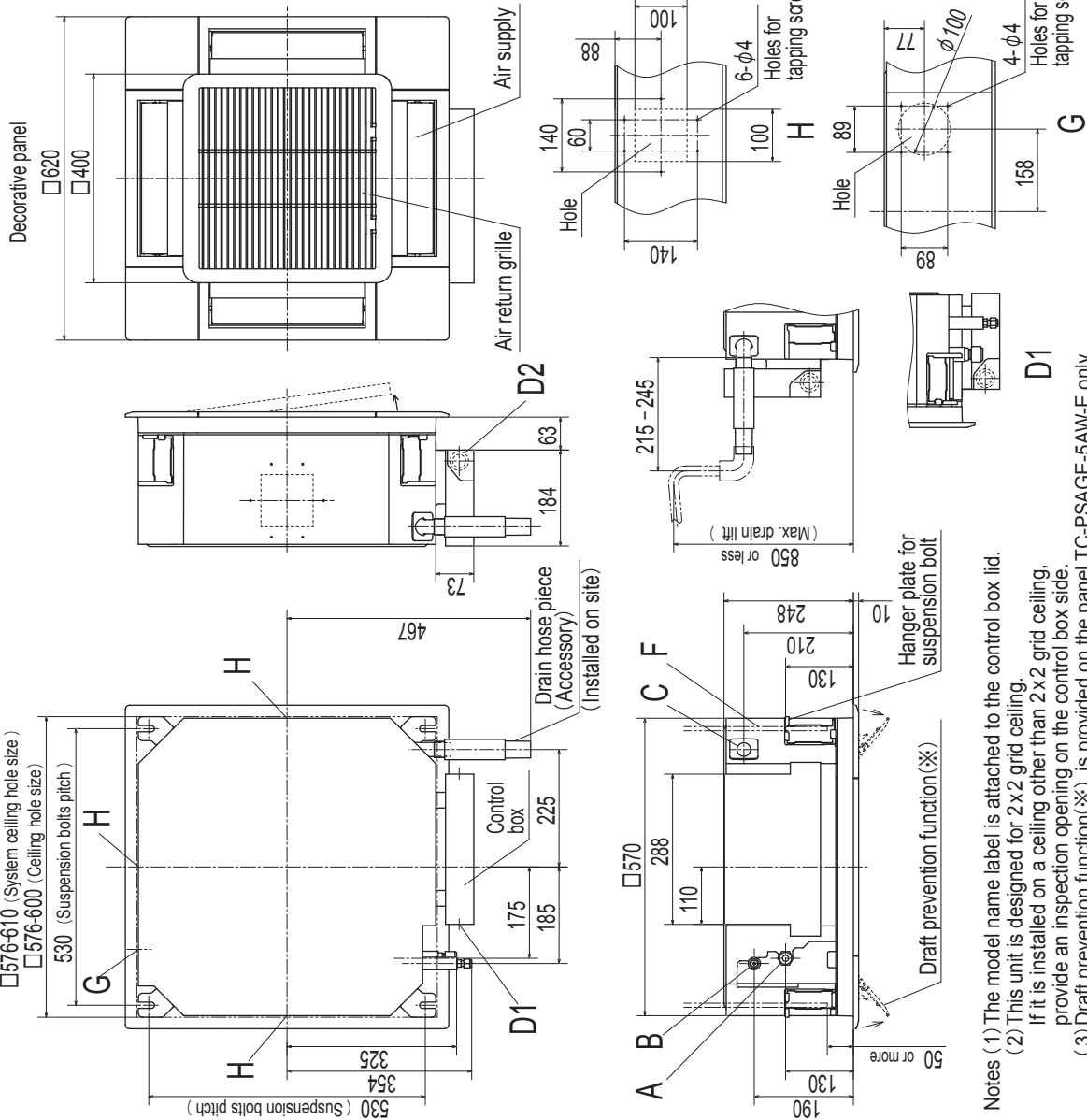

Unit: mm

Panel model name
TC-PSAG-5AW-E
TC-PSAGE-5AW-E

- Notes (1) The model name label is attached to the control box lid.
 (2) This unit is designed for 2x2 grid ceiling.
 If it is installed on a ceiling other than 2x2 grid ceiling, provide an inspection opening on the control box side.
 (3) Draft prevention function(※) is provided on the panel TC-PSAGE-5AW-E only.

(2) Honeycomb type

Symbol	Model	Content
A	Gas piping	25.35 φ9.52 (3/8") (Flare) φ12.7 (1/2") (Flare)
B	Liquid piping	φ6.35 (1/4") (Flare)
C	Drain piping	VP25 (O.D.32)
D1	Power source connection	
D2	Remote control code and signal wiring connection	
F	Suspension bolts	(M10 or M8)
G	Outside air opening for ducting	(Knock out)
H	Air outlet opening for ducting	φ125 (Knock out)
J	Inspection opening	450×450

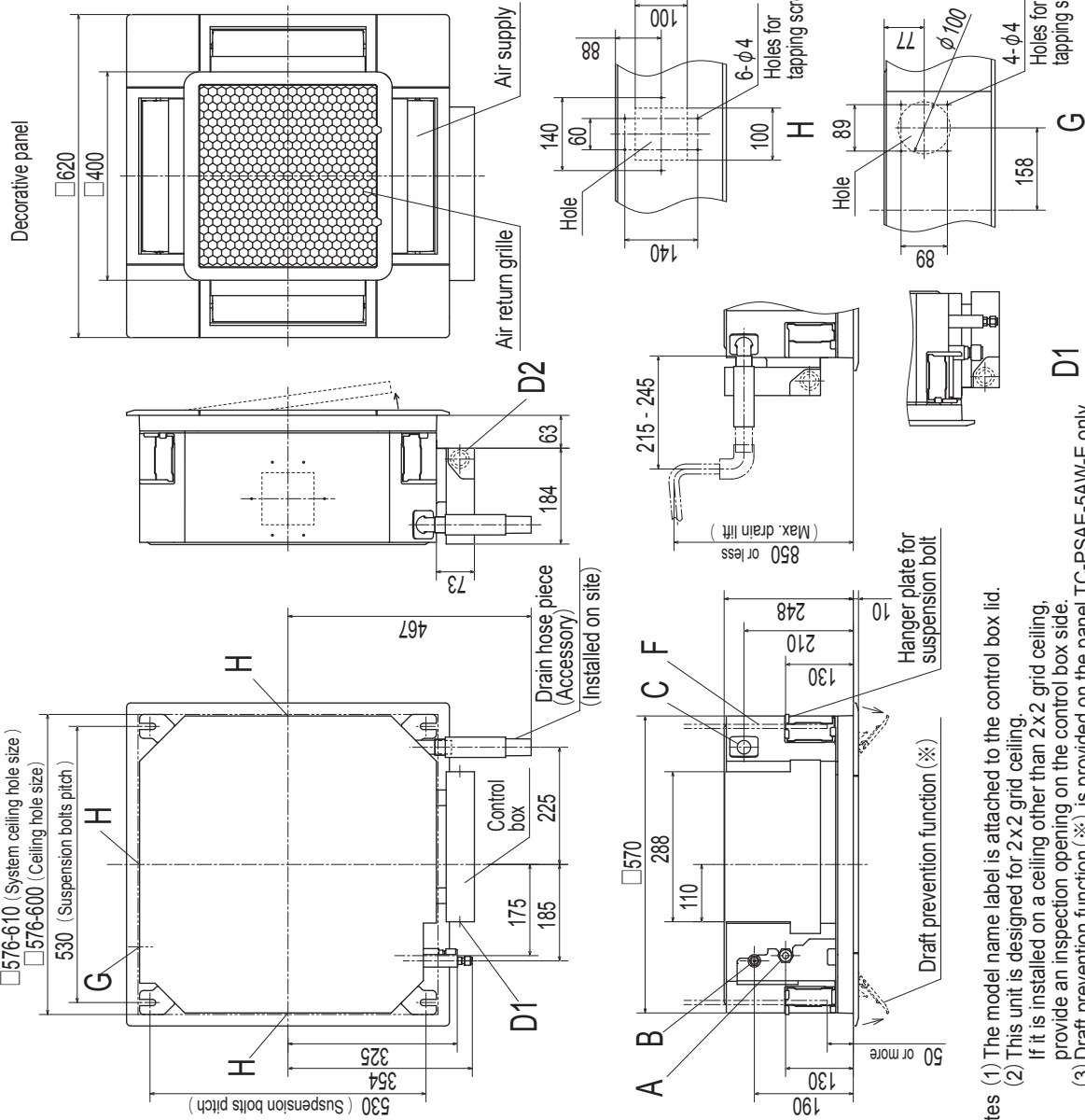

- Notes
- (1) The model name label is attached to the control box lid.
 - (2) This unit is designed for 2x2 grid ceiling. If it is installed on a ceiling other than 2x2 grid ceiling, provide an inspection opening on the control box side.
 - (3) Draft prevention function (※) is provided on the panel TC-PSAE-5AW-E only.

Models FDTC15KXZE1, 22KXZE1, 28KXZE1, 36KXZE1, 45KXZE1, 56KXZE1

(1) Grid type

Symbol	Model	Content
A	Gas piping	15,22,28 φ9.52 (3/8") (Flare) φ12.7 (1/2") (Flare)
B	Liquid piping	φ6.35 (1/4") (Flare)
C	Drain piping	VP25 (O.D.32)
D1	Power source connection	
D2	Remote control code and signal wiring connection	
F	Suspension bolts	(M10 or M8)
G	Outside air opening for ducting	(Knock out)
H	Air outlet opening for ducting	φ125 (Knock out)
J	Inspection opening	450x450

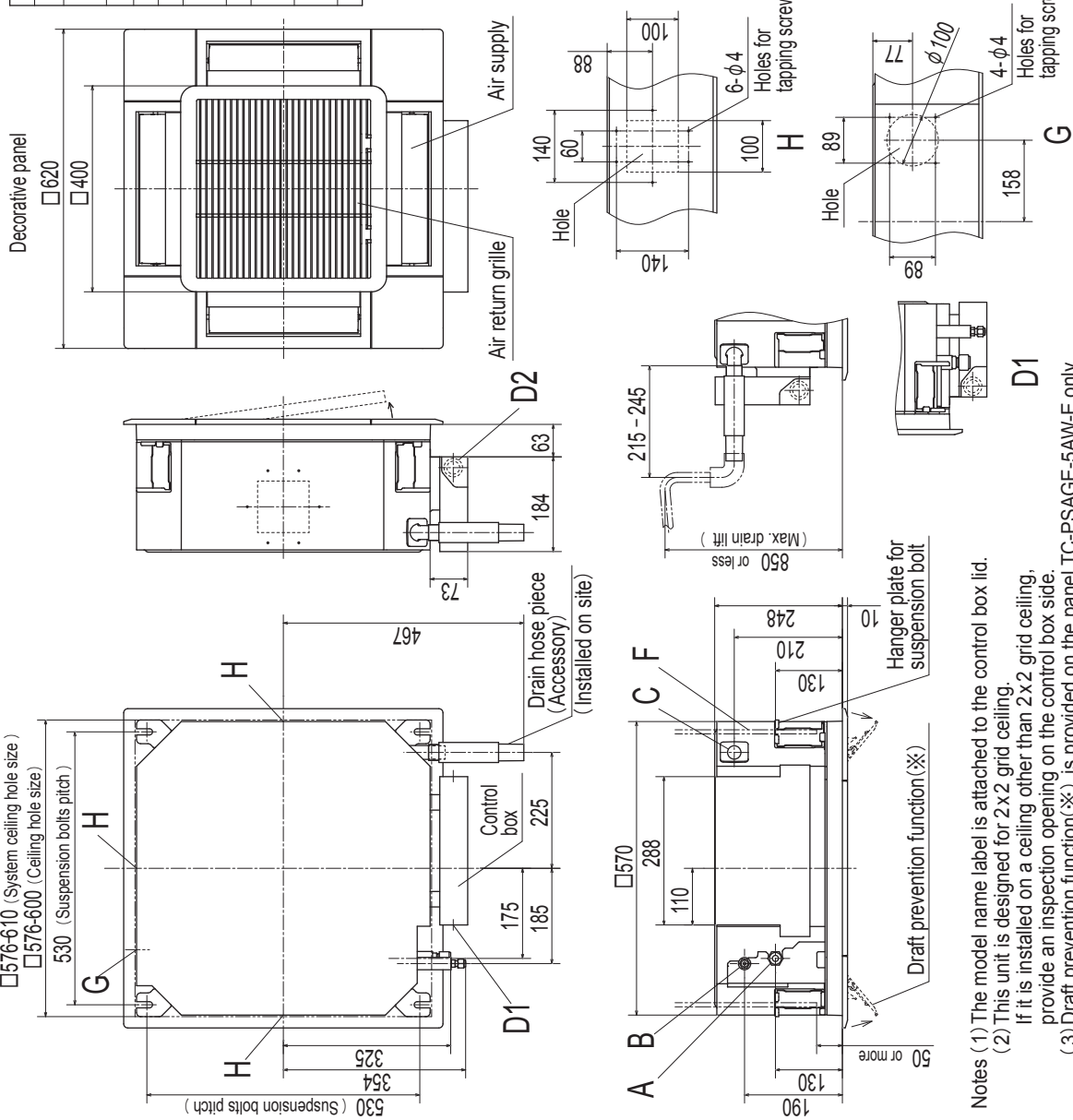

Unit mm

Panel model name
TC-PSAG-5AW-E
TC-PSAGE-5AW-E

- Notes (1) The model name label is attached to the control box lid.
 (2) This unit is designed for 2x2 grid ceiling. If it is installed on a ceiling other than 2x2 grid ceiling, provide an inspection opening on the control box side.
 (3) Draft prevention function(*) is provided on the panel TC-PSAGE-5AW-E only.

(2) Honeycomb type

Symbol	Model	Content
A	Gas piping	15.22.28 φ9.52 (3/8") (Flare) φ12.7 (1/2") (Flare)
B	Liquid piping	φ6.35 (1/4") (Flare)
C	Drain piping	VP25 (O.D.32)
D1	Power source connection	
D2	Remote control code and signal wiring connection	
F	Suspension bolts	(M10 or M8)
G	Outside air opening for ducting	(Knock out)
H	Air outlet opening for ducting	φ125 (Knock out)
J	Inspection opening	450X450

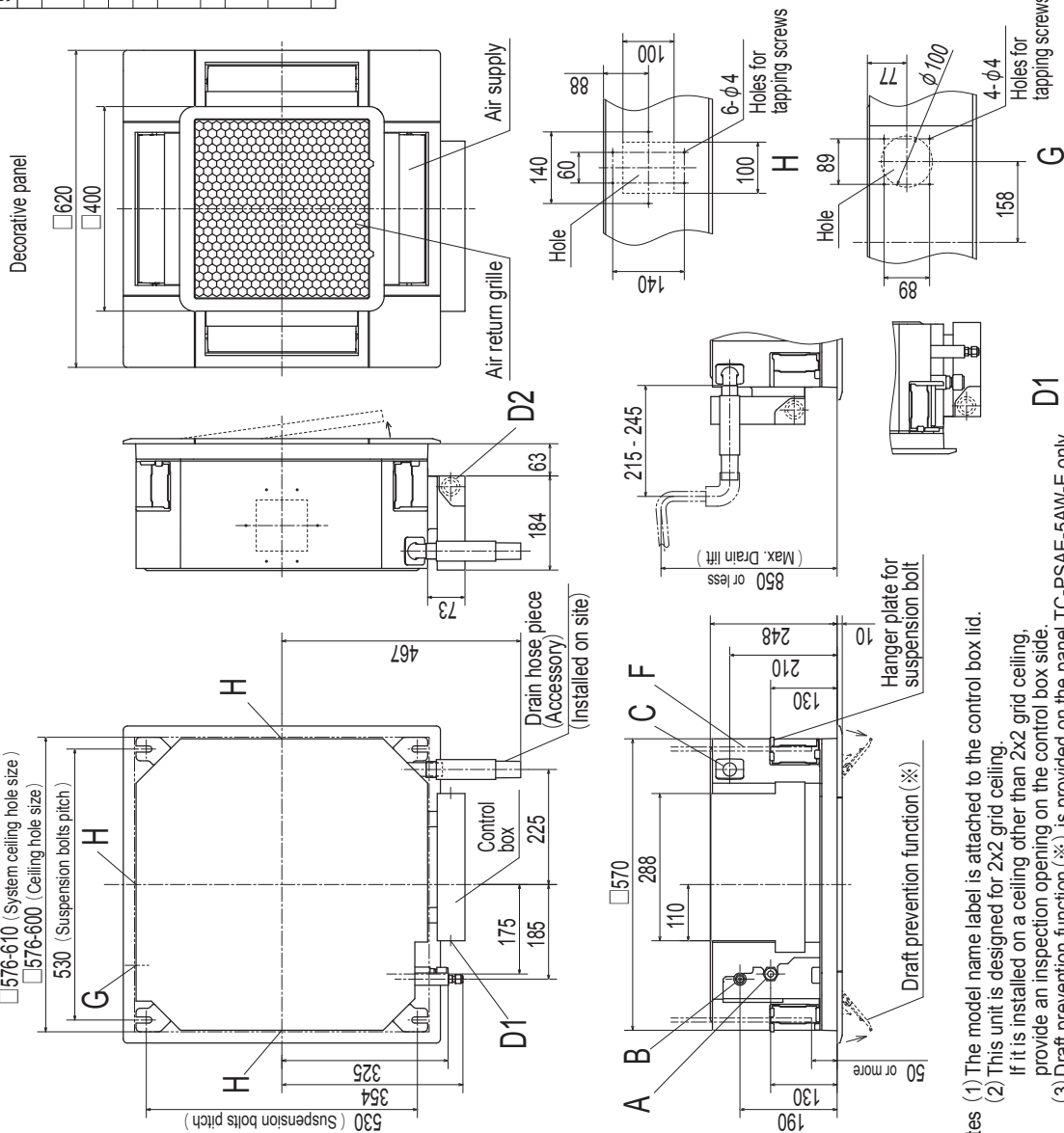

Unit: mm

Panel model name
TC-PSA-5AW-E
TC-PSAE-5AW-E

- Notes
- (1) The model name label is attached to the control box lid.
 - (2) This unit is designed for 2x2 grid ceiling. If it is installed on a ceiling other than 2x2 grid ceiling, provide an inspection opening on the control box side.
 - (3) Draft prevention function (※) is provided on the panel TC-PSAE-5AW-E only.

2. ELECTRICAL WIRING

Ceiling cassette-4 way compact type (FDTC)

Models FDTC25VG, 35VG, 40VG, 50VG, 60VG

FDTC25VH, 35VH, 40VH, 50VH, 60VH

Meaning of marks

Item	Description
AM1-4	Draft prevention function motor
CNB-Z	Connector
DM	Drain pump motor
F1,2	Fuse
FMI	Fan motor
FS	Float switch
HS	Humidity sensor
LED-2	Indication lamp (Green-Normal operation)
LED-3	Indication lamp (Red-Inspection)
LM1-4	Lower motor
PIS	Motion sensor
SW2	Remote control communication address
SW5	Plural units Master/ Slave setting
SW6	Model capacity setting
SW7-1	Operation check drain pump motor test run
TB1	Terminal block (Power source) (□mark)
TB2	Terminal block (Signal line) (□mark)
Thc	Temperature sensor (Remote control)
Thi-A	Temperature sensor (Return air)
Thi-R1,2,3	Temperature sensor (Heat exchanger)

Color marks

Mark	Color	Mark	Color
BK	Black	WH	White
BL	Blue	YE	Yellow
BR	Brown	GY	Gray
OR	Orange	YE/GN	Yellow/Green
RD	Red		

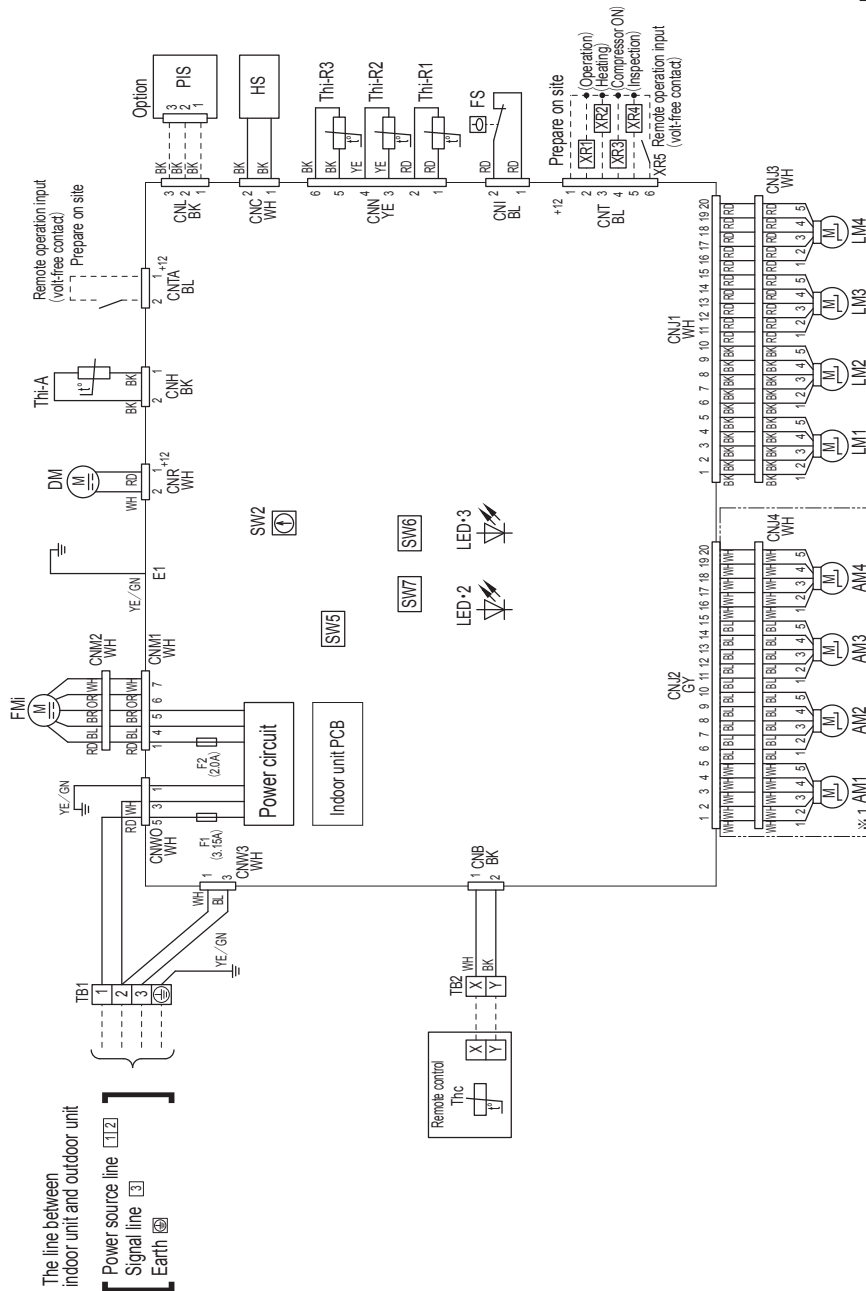

Notes 1. - - - - indicates wiring on site.

2. See the wiring diagram of outdoor unit about the line between indoor unit and outdoor unit.

3. Use twin core cord (0.3mm²) at remote control line.

4. Do not put remote control line alongside power source line.

5. Draft prevention function (※ 1) is provided on the panel TC-PSAE-5AW-E, TC-PSAGE-5AW-E only.

Models FDTC15KXZE1, 22KXZE1, 28KXZE1, 36KXZE1, 45KXZE1, 56KXZE1

Meaning of marks

Item	Description
AM1-4	Draft prevention function motor
CNA-Z	Connector
DM	Drain pump motor
F1,2	Fuse
FMI	Fan motor
FS	Float switch
HS	Humidity sensor
JSL1	Spare Superlink connector change
LED-2	Indication lamp (Green-Normal operation)
LED-3	Indication lamp (Red-Inspection)
LM1-4	Louver motor
PIS	Motion sensor
SM	Stepping motor (For electronic expansion valve)
SW1	Indoor unit address: tens place
SW2	Indoor unit address: ones place
SW3	Outdoor unit address: tens place
SW4	Outdoor unit address: ones place
SW5-1	Automatic adjustment / Fixed previous version of superlink protocol
SW5-2	Indoor unit address: hundreds place
SW6, SW7-2	Model capacity setting
SW7-1	Operation check, drain pump motor test run
TB1	Terminal block (Power source) (□mark)
TB2	Terminal block (Signal line) (□mark)
Thc	Temperature sensor (Remote control)
Thi-A	Temperature sensor (Return air)
Thi-R1,2,3	Temperature sensor (Heat exchanger)

Color marks

Mark	Color	Mark	Color
BK	Black	WH	White
BL	Blue	YE	Yellow
BR	Brown	GY	Gray
OR	Orange	YE/GN	Yellow/Green
RD	Red		

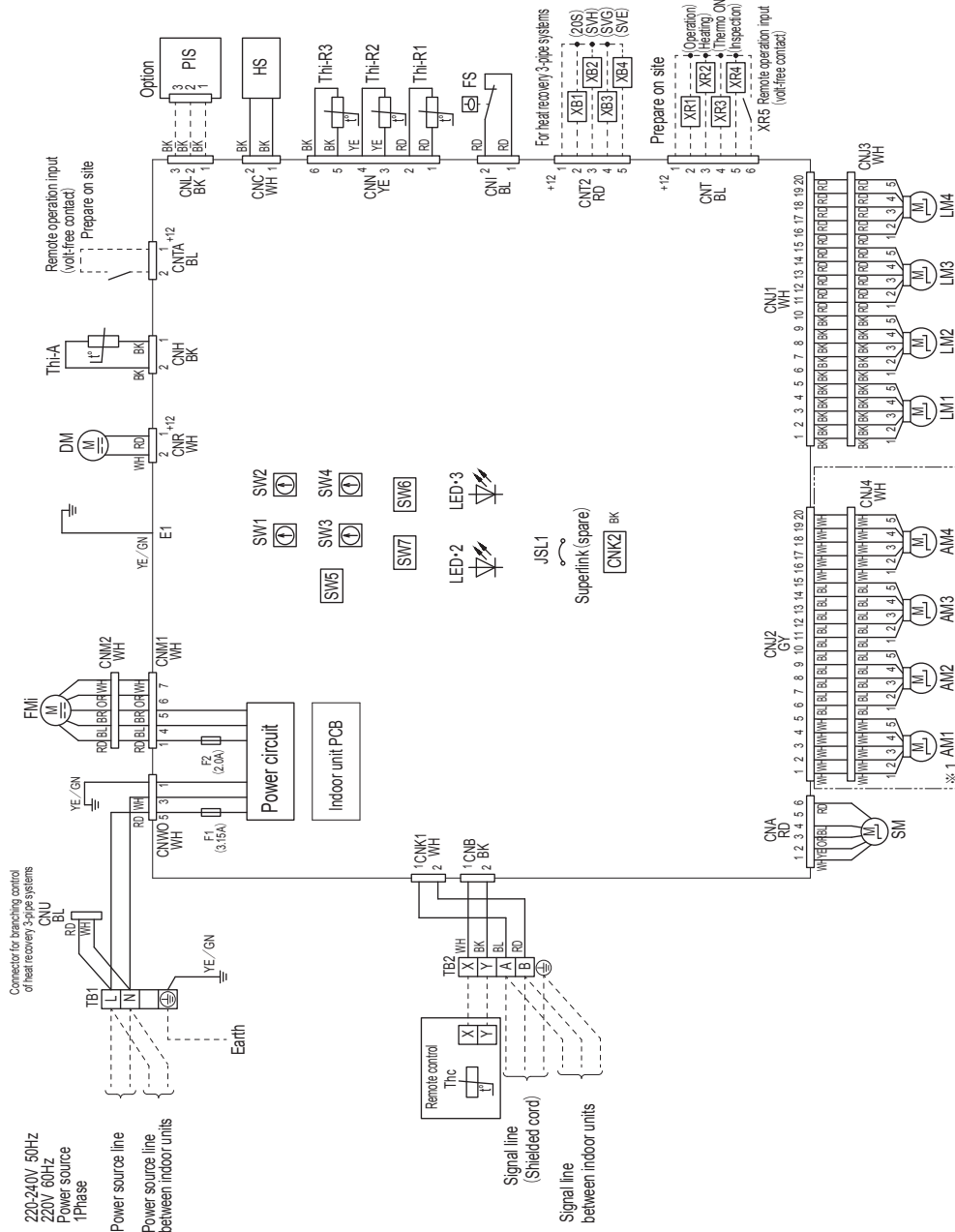

- Notes
- 1: --- indicates wiring on site.
 - 2: Use twin core shielded cord (0.75-1.25mm²) at signal line between indoor unit and outdoor unit, and signal line between indoor units.
 - 3: Use twin core cord (0.3mm²) at remote control line.
 - 4: See spec sheet of remote control in case that the total length is more than 100m. Do not put signal line and remote control line alongside power source line.
 - 5: Draft prevention function (※ 1) is provided on the panel TC-PSAE-5AW-E, TC-PSAGE-5AW-E only.

3. INSTALLATION OF INDOOR UNIT

Ceiling cassette-4 way compact type(FDTC)

PJF012D509

This manual is for the installation of the indoor unit.
For the panel installation, refer to page 43. For wireless kit installation, refer to page 48. For motion sensor kit installation, refer to page 56. This unit must always be used with the panel.

SAFETY PRECAUTIONS

- Read the "SAFETY PRECAUTIONS" carefully first of all and then strictly follow it during the installation work in order to protect yourself.
- The precautionary items mentioned below are distinguished into two levels, and .
: Wrong installation would cause serious consequences such as injuries or death.
: Wrong installation might cause serious consequences depending on circumstances.
Both mentions the important items to protect your health and safety so strictly follow them by any means.
- The meanings of "Marks" used here are as shown on the right:
 Never do it under any circumstances.
 Always do it according to the instruction.
- After completing the installation, do commissioning to confirm there are no abnormalities, and explain to the customers about "SAFETY PRECAUTIONS", correct operation method and maintenance method (air filter cleaning, operation method and temperature setting method) with user's manual of this unit.
Ask your customers to keep this installation manual together with the user's manual. Also, ask them to hand over the user's manual to the new user when the owner is changed.

WARNING

- **Installation should be performed by the specialist.**
If you install the unit by yourself, it may lead to serious trouble such as water leakage, electric shock, fire, and injury due to overturn of the unit.
- **Install the system correctly according to these installation manuals.**
Improper installation may cause explosion, injury, water leakage, electric shock, and fire.
- **Check the density referred by the formula (accordance with ISO5149).**
If the density exceeds the limit density, please consult the dealer and installate the ventilation system.
- **Use the genuine accessories and the specified parts for installation.**
If parts unspecified by our company are used it could cause water leakage, electric shock, fire, and injury due to overturn of the unit.
- **Ventilate the working area well in case the refrigerant leaks during installation.**
If the refrigerant contacts the fire, toxic gas is produced.
In case of R32, the refrigerant could be ignited because of its flammability.
- **Install the unit in a location that can hold heavy weight.**
Improper installation may cause the unit to fall leading to accidents.
- **Install the unit properly in order to be able to withstand strong winds such as typhoons, and earthquakes.**
Improper installation may cause the unit to fall leading to accidents.
- **Do not mix air in to the cooling cycle on installation or removal of the air-conditioner.**
If air is mixed in, the pressure in the cooling cycle will rise abnormally and may cause explosion and injuries.
- **Be sure to have the electrical wiring work done by qualified electrical installer, and use exclusive circuit.**
Power source with insufficient capacity and improper work can cause electric shock and fire.
- **Use specified wire for electrical wiring, fasten the wiring to the terminal securely, and hold the cable securely in order not to apply unexpected stress on the terminal.**
Loose connections or hold could result in abnormal heat generation or fire.
- **Arrange the electrical wires in the control box properly to prevent them from rising. Fit the lid of the services panel properly.**
Improper fitting may cause abnormal heat and fire.
- **Check for refrigerant gas leakage after installation is completed.**
If the refrigerant gas leaks into the house and comes in contact with a fan heater, a stove, or an oven, toxic gas is produced.
- **Use the specified pipe, flare nut, and tools for R32 or R410A.**
Using existing parts (R22) could cause the unit failure and serious accident due to explosion of the cooling cycle.
- **Tighten the flare nut according to the specified method by with torque wrench.**
If the flare nut were tightened with excess torque, it could cause burst and refrigerant leakage after a long period.
- **Do not put the drainage pipe directly into drainage channels where poisonous gases such as sulfide gas can occur.**
Poisonous gases will flow into the room through drainage pipe and seriously affect the user's health and safety. This can also cause the corrosion of the indoor unit and a resultant unit failure or refrigerant leak.
- **Connect the pipes for refrigeration circuit securely in installation work before compressor is operated.**
If the compressor is operated when the service valve is open without connecting the pipe, it could cause explosion and injuries due to abnormal high pressure in the system.
- **Stop the compressor before removing the pipe after shutting the service valve on pump down work.**
If the pipe is removed when the compressor is in operation with the service valve open, air would be mixed in the refrigeration circuit and it could cause explosion and injuries due to abnormal high pressure in the cooling cycle.
- **Only use prescribed option parts. The installation must be carried out by the qualified installer.**
If you install the system by yourself, it can cause serious trouble such as water leaks, electric shocks, fire.
- **Do not repair by yourself. And consult with the dealer about repair.**
Improper repair may cause water leakage, electric shock or fire.
- **Consult the dealer or a specialist about removal of the air-conditioner.**
Improper installation may cause water leakage, electric shock or fire.
- **Turn off the power source during servicing or inspection work.**
If the power is supplied during servicing or inspection work, it could cause electric shock and injury by the operating fan.
- **Do not run the unit when the panel or protection guard are taken off.**
Touching the rotating equipment, hot surface, or high voltage section could cause an injury to be caught in the machine, to get burned, or electric shock.
- **Shut off the power before electrical wiring work.**
It could cause electric shock, unit failure and improper running.

CAUTION

- **Perform earth wiring surely.**
Do not connect the earth wiring to the gas pipe, water pipe, lightning rod and telephone earth wiring. Improper earth could cause unit failure and electric shock due to a short-circuit.
- **Earth leakage breaker must be installed.**
If the earth leakage breaker is not installed, it can cause electric shocks.
- **Use the circuit breaker of correct capacity. Circuit breaker should be the one that disconnect all poles under over current.**
Using the incorrect one could cause the system failure and fire.
- **Do not use any materials other than a fuse of correct capacity where a fuse should be used.**
Connecting the circuit by wire or copper wire could cause unit failure and fire.
- **Do not install the indoor unit near the location where there is possibility of flammable gas leakages.**
If the gas leaks and gathers around the unit, it could cause fire.
- **Do not install and use the unit where corrosive gas (such as sulfuric acid gas etc.) or flammable gas (such as thinner, petroleum etc.) may be generated or accumulated, or volatile flammable substances are handled.**
It could cause the corrosion of heat exchanger, breakage of plastic parts etc. And inflammable gas could cause fire.
- **Secure a space for installation, inspection and maintenance specified in the manual.**
Insufficient space can result in accident such as personal injury due to falling from the installation place.
- **Do not use the indoor unit at the place where water splashes such as laundry.**
Indoor unit is not waterproof. It could cause electric shock and fire.
- **Do not use the indoor unit for a special purpose such as food storage, cooling for precision instrument, preservation of animals, plants, and a work of art.**
It could cause the damage of the items.
- **Do not install nor use the system near equipments which generate electromagnetic wave or high harmonics.**
Equipments like inverter equipment, private power generator, high-frequency medical equipment, or telecommunication equipment might influence the air-conditioner and cause a malfunction and breakdown. Or the air-conditioner might influence medical equipments or telecommunication equipments, and obstruct their medical activity or cause jamming.
- **Do not install the remote control at the direct sunlight.**
It could cause breakdown or deformation of the remote control.
- **Do not install the indoor unit at the place listed below.**
 - Places where flammable gas could leak.
 - Places where carbon fiber, metal powder or any powder is floated.
 - Place where the substances which affect the air conditioner are generated such as sulfide gas, chloride gas, acid, alkali or ammoniac atmospheres.
 - Places exposed to oil mist or steam directly.
 - On vehicles and ships
 - Places where machinery which generates high harmonics is used.
 - Places where cosmetics or special sprays are frequently used.
 - Highly salted area such as beach.
 - Heavy snow area
 - Places where the system is affected by smoke from a chimney.
 - Altitude over 1000m
- **Do not install the indoor unit in the locations listed below (Be sure to install the indoor unit according to the installation manual for each model because each indoor unit has each limitation)**
 - Locations with any obstacles which can prevent inlet and outlet air of the unit
 - Locations where vibration can be amplified due to insufficient strength of structure.
 - Locations where the infrared receiver is exposed to the direct sunlight or the strong light beam. (In case of the Infrared specification unit)
 - Locations where an equipment affected by high harmonics is placed. (TV set or radio receiver is placed within 5m)
 - Locations where drainage cannot run off safely. It can affect performance or function and etc..
 - Do not install the motion sensor mounting panel at following places. It could cause detection error, incapacity of detection, or characteristic degradation.
 - Place where vibration is applied to it for a long period of time.
 - Place where static electricity or electromagnetic wave generates.
 - Place where it is exposed to high temperature or humidity for a long period of time.
 - Dusty place or where the lens face could be fouled or damaged.
- **Do not put any valuables which will break down by getting wet under the air-conditioner.**
Condensation could drop when the relative humidity is higher than 80% or drain pipe is clogged, and it damages user's belongings.
- **Do not use the base frame for the outdoor unit which is corroded or damaged after a long period of use.**
It could cause the unit falling down and injury.
- **Pay attention not to damage the drain pan by weld sputter when brazing work is done near the unit.**
If sputter entered into the unit during brazing work, it could cause damage (pinhole) of drain pan and leakage of water. To avoid damaging, keep the indoor unit packed or cover the indoor unit.
- **Install the drain pipe to drain the water surely according to the installation manual.**
Improper connection of the drain pipe may cause dropping water into room and damaging user's belongings.
- **Be sure to perform air tightness test by pressurizing with nitrogen gas after completed refrigerant piping work.**
If the density of refrigerant exceeds the limit in the event of refrigerant leakage in the small room, lack of oxygen can occur, which can cause serious accidents.
- **For drain pipe installation, be sure to make descending slope of greater than 1/100, not to make traps, and not to make air-bleeding.**
Check if the drainage is correctly done during commissioning and ensure the space for inspection and maintenance.
- **Ensure the insulation on the pipes for refrigeration circuit so as not to condense water.**
Incomplete insulation could cause condensation and it would wet ceiling, floor, and any other valuables.
- **Do not install the outdoor unit where is likely to be a nest for insects and small animals.**
Insects and small animals could come into the electronic components and cause breakdown and fire. Instruct the user to keep the surroundings clean.
- **Pay extra attention, carrying the unit by hand.**
Carry the unit with 2 people if it is heavier than 20kg. Do not use the plastic straps but the grabbing place, moving the unit by hand. Use protective gloves in order to avoid injury by the aluminum fin.
- **Make sure to dispose of the packaging material.**
Leaving the materials may cause injury as metals like nail and woods are used in the package.
- **Do not operate the system without the air filter.**
It may cause the breakdown of the system due to clogging of the heat exchanger.
- **Do not touch any button with wet hands.**
It could cause electric shock.
- **Do not touch the refrigerant piping with bare hands when in operation.**
The pipe during operation would become very hot or cold according to the operating condition, and it could cause a burn or frostbite.
- **Do not clean up the air-conditioner with water.**
It could cause electric shock.
- **Do not turn off the power source immediately after stopping the operation.**
Be sure to wait for more than 5 minutes. Otherwise it could cause water leakage or breakdown.
- **Do not connect the operation with the circuit breaker.**
It could cause fire or water leakage. In addition, the fan may start operation unexpectedly and it may cause injury.

① Before installation

- Install correctly according to the installation manual.
- Confirm the following points:
 - Unit type/Power source specification
 - Pipes/Wires/Small parts
 - Accessory items

When moving the indoor unit, hold only the hanging hardware (4 places) only, with care not to apply forces to any other parts of the unit (particularly the refrigerant pipe, drain pipe, and resin parts).

Accessory item

For unit hanging		For refrigerant pipe			For drain pipe			
Flat washer (M10)	Level gage	Pipe cover(big)	Pipe cover (small)	Strap	Pipe cover(big)	Pipe cover(small)	Drain hose	Hose clamp
1	1	1	1	4	1	1	1	1
For unit hanging	For leveling and alignment of air supply port	For heat insulation of gas pipe	For heat insulation of liquid tube	For pipe cover fixing	For heat insulation of drain socket	For heat insulation of drain socket	For drain pipe connecting	For drain hose mounting

② Selection of installation location for the indoor unit

- Select the suitable areas to install the unit under approval of the user.
 - Areas where the indoor unit can deliver hot and cold wind sufficiently. Suggest to the user to use a circulator if the ceiling height is over 3m to avoid warm air being accumulated on the ceiling.
 - In case of the panel having the motion sensor, the installation height must be no higher than 4 m. It could reduce the sensitivity of motion sensor, disabling the detection.
 - Areas where there is enough space to install and service.
 - Areas where it can be drained properly. Areas where drain pipe descending slope can be taken.
 - Areas where there is no obstruction of air flow on both air return grille and air supply port.
 - Areas where fire alarm will not be accidentally activated by the air-conditioner.
 - Areas where the supply air does not short-circuit.
 - Areas where it is not influenced by draft air.
 - Areas not exposed to direct sunlight.
 - Areas where dew point is lower than around 28°C and relative humidity is lower than 80%. This indoor unit is tested under the condition of JIS (Japan Industrial Standard) high humidity condition and confirmed there is no problem. However, there is some risk of condensation drop if the air-conditioner is operated under the severer condition than mentioned above.
 - If there is a possibility to use it under such a condition, attach additional insulation of 10 to 20mm thick for entire surface of indoor unit, refrigeration pipe and drain pipe.
 - Areas where TV and radio stays away more than 1m. (It could cause jamming and noise.)
 - Areas where any items which will be damaged by getting wet are not placed such as food, table wares, server, or medical equipment under the unit.
 - Areas where there is no influence by the heat which cookware generates.
 - Areas where not exposed to oil mist, powder and/or steam directly such as above fryer.
 - Areas where lighting device such as fluorescent light or incandescent light doesn't affect the operation. (A beam from lighting device sometimes affects the infrared receiver for the wireless remote control and the air-conditioner might not work properly.)
- Check if the place where the air-conditioner is installed can hold the weight of the unit. If it is not able to hold, reinforce the structure with boards and beams strong enough to hold it. If the strength is not enough, it could cause injury due to unit falling.
- If there are 2 units of wireless type, keep them away for more than 6m to avoid malfunction due to cross communication.
- When plural indoor units are installed nearby, keep them away for more than 4m.

Space for installation and service

- When it is not possible to keep enough space between indoor unit and wall or between indoor units, close the air supply port where it is not possible to keep space and confirm there is no short-circuit of air flow.
- Install the indoor unit at a height of more than 2.5m above the floor.

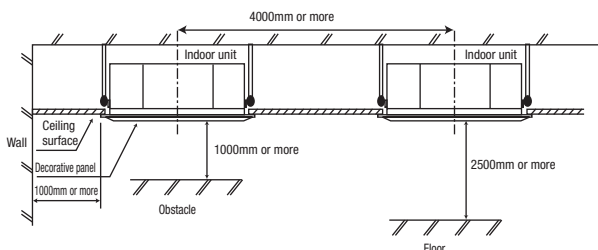

Set blow-out pattern

- Select the most proper number of blow-out air supply port direction from 4 way, 3 way or 2 way according to the shape of the room and installation position. (1 way is not available.)
- If it is necessary to change the number of air supply port, prepare the covering materials. (sold as accessory)
- Instruct the user not to use low fan speed when 2way or 3way air supply is used.
- Do not use 2way air supply port under high temperature and humidity environment. (Otherwise it could cause condensation and leakage of water.)
- It is possible to set the air flow direction port by port independently. Refer to the user's manual for details.

Where there are pipe joints on the way of embedded piping, provide adequate openings for inspection of the joints.

③ Preparation before installation

- If suspension bolt becomes longer, do reinforcement of earthquake resistant.
 - For grid ceiling
 - When suspension bolt length is over 500mm, or the gap between the ceiling and roof is over 700mm, apply earthquake resistant brace to the bolt.
 - In case the unit is hanged directly from the slab and is installed on the ceiling plane which has enough strength.
 - When suspension bolt length is over 1000mm, apply the earthquake resistant brace to the bolt.
- Prepare four (4) sets of suspension bolt, nut and spring washer (M10 or M8) on site.

Ceiling opening, Suspension bolts pitch, Pipe position

Symbol	Content
A	Gas piping
B	Liquid piping
C	Drain piping
D	Power source connection
Dz	Remote control code and signal wiring connection
F	Suspension bolts
G	Outside air opening for ducting
H	Air outlet opening for ducting
J	Inspection opening

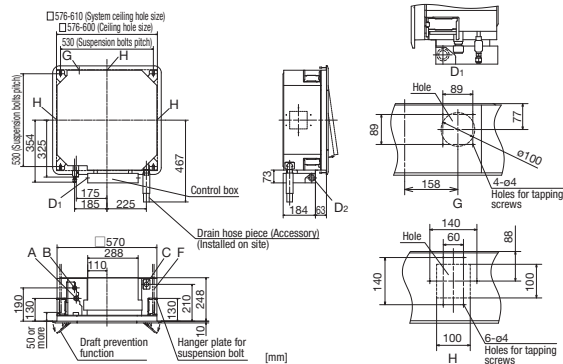
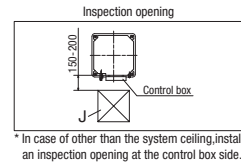

④ Installation of indoor unit

Work procedure

- This unit is designed to install on a system ceiling. If necessary, remove T bars temporarily before installing the unit. When it is installed on a ceiling other than the system ceiling, install an inspection port at the control box side.
- Determine the position of suspension bolts (530mm × 530mm).
- Use 4 suspension bolts, and fix them such that each bolt can withstand a pull-out load of 500N.
- Set the suspension bolt length to about 50mm from the ceiling.
- Temporarily locate the lower nuts of the suspension bolts (4 places) at a position approximately 130 mm from the ceiling.
- Temporarily locate the upper nuts of the suspension bolts (4 places) at positions sufficiently distance from the lower nuts so that they do not interfere with the suspension of the indoor unit and with its height adjustment.
- Set the upper nuts of the suspension bolts and upper washers (4 places) at positions sufficiently distance from the lower nuts. Then, push and insert the temporary fixing carton of washers (*1) onto suspension bolts. Make sure that the upper washers do not slide down.
- Suspend the indoor unit.
- After suspending the indoor unit, mount the level gauge (*2) to the air outlet of the indoor unit, and adjust the suspension height of the indoor unit. Loosen the upper nuts (4 places), and adjust the suspension height using the lower nuts (4 places). Confirm there is no slack between the lower nuts and flat washers of the indoor unit hanger plate (4 places).
- Remove the temporary fixing carton of washers (from all 4 places).
- Make sure that the indoor unit is installed horizontally. Confirm the levelness of the indoor unit using a level gauge or transparent hose filled with water. (Keep the height difference at both ends of the indoor unit within 3mm.)
- Tighten the upper nuts of the suspension bolts (4 places).

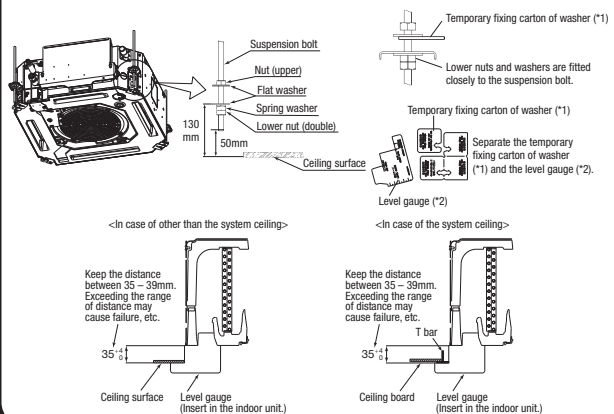

④ Installation of indoor unit (continued)

Protection of the indoor unit

- If it is not possible to install the panel for a while or if attaching the ceiling board after installing the indoor unit, protect the indoor unit by using upper carton.

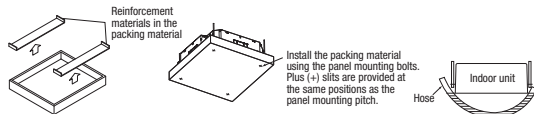

Caution

- Do not adjust the unit height by adjusting the upper nuts. Doing so will cause unexpected stress on the indoor unit and cause the unit to become deformed, prevent the panel from being installed, and be generated fan interference noise.
- Make sure that the indoor unit is installed horizontally and set the appropriate gap between the underside of the unit and the ceiling plane. Improper installation may cause air leakage, dew condensation, water leakage and noise.
- Make sure there is no gap between the panel and the ceiling surface, and between the panel and the indoor unit. Any gap may cause air and/or water to leak, or condensation to form.

⑤ Refrigerant pipe

Caution

- Be sure to use new pipes for the refrigerant pipes. Use the flare nut attached to the product. Regarding whether existing pipes can be reused or not, and the washing method, refer to the instruction manual of the outdoor unit, catalogue or technical data.
- 1) In case of reuse: Do not use old flare nut, but use the nut attached to the unit.
- 2) In case of reuse: Flare the end of pipe replaced partially for R32 or R410A.

WARNING : When flared joints are reused indoors, the flare part shall be re-fabricated. (only for R32)

Pipe diameter d mm	Min. pipe wall thickness mm	Protruding dimension for flare, mm		Flare O.D. D mm	Flare nut tightening torque N·m
		Rigid (Clutch type) For R32 For R410A	Conventional tool		
6.35	0.8	0 - 0.5	0.7 - 1.3	8.9 - 9.1	14 - 18
9.52	0.8			12.8 - 13.2	34 - 42
12.7	0.8			16.2 - 16.6	49 - 61
15.88	1			19.3 - 19.7	68 - 82
19.05	1.2			23.6 - 24.0	100 - 120

- Use phosphorus deoxidized copper alloy seamless pipe (C1220T) for refrigeration pipe installation. In addition, make sure there is no damage both inside and outside of the pipe, and no harmful substances such as sulfur, oxide, dust or a contaminant stuck on the pipes.
- Do not use any refrigerant other than the designated refrigerant. Using other refrigerant except the designated refrigerant, may degrade inside refrigeration oil. And air getting into refrigeration circuit may cause over-pressure and resultant it may result in bursting, etc.
- Store the copper pipes indoors and seal the both end of them until they are brazed in order to avoid any dust, dirt or water getting into pipe. Otherwise it will cause degradation of refrigeration oil and compressor breakdown, etc.
- Use special tools for R32 or R410A refrigerant.

Work procedure

- Remove the flare nut and blind flanges on the pipe of the indoor unit.
 - ※ Make sure to loosen the flare nut with holding the nut on pipe side with a spanner and giving torque to the nut with another spanner in order to avoid unexpected stress to the copper pipe, and then remove them. (Gas may come out at this time, but it is not abnormal.)
 - Pay attention whether the flare nut pops out. (as the indoor unit is sometimes pressured.)
- Make a flare on liquid pipe and gas pipe, and connect the refrigeration pipes on the indoor unit.
 - ※ Bend radius of pipe must be 4D or larger. Once a pipe is bent, do not readjust the bending. Do not twist a pipe or collapse to 2/3D or smaller.
 - Make sure to use flare nuts assembled on the unions. Usage of other flare nuts could cause refrigerant leakage.
 - ※ Do a flare connection as follows:
 - Make sure to hold the nut on indoor unit pipe side using double spanner method as indicated when fastening / loosening flare nuts in order to prevent unintentional twisting of the copper pipe.
 - When fastening the flare nut, align the refrigeration pipe with the center of flare nut, screw the nut for 3-4 times by hand and then tighten it by spanner with the specified torque mentioned in the table above.
- Cover the flare connection part of the indoor unit with attached insulation material after a gas leakage inspection, and tighten both ends with attached straps.
 - Make sure to insulate both gas pipes and liquid pipes completely.
 - ※ Incomplete insulation may cause dew condensation or water dropping.
 - Use heat-resistant (120°C or more) insulations on the gas side pipes.
 - In case of using at high humidity condition, reinforce insulation of refrigerant pipes. Surface of insulation may cause dew condition or water dropping, if insulations are not reinforced.
- Refrigerant is charged in the outdoor unit. As for the additional refrigerant charge for the indoor unit and piping, refer to the installation manual attached to the outdoor unit.

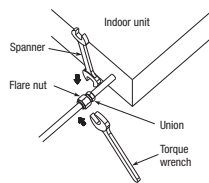

⑤ Refrigerant pipe (continued)

Caution:

Refrigerating machine oil should not be applied to the threads of union or external surface of flare. It is because, even if the same tightening torque is applied, the oil is likely to decrease the slide friction force on the threads and increase, in turn, the axial component force so that it could crack the flare by the stress corrosion. Refrigerating machine oil may be applied to the internal surface of flare only.

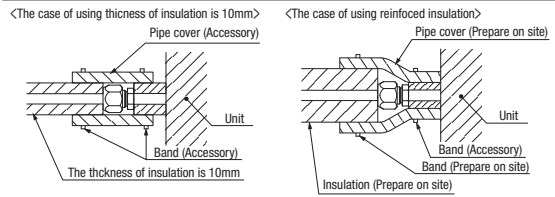

⑥ Drain pipe

Caution

- Install the drain pipe according to the installation manual in order to drain properly. Imperfection in draining may cause flood indoors and wetting the household goods, etc.
- Do not put the drain pipe directly into the ditch where toxic gas such as sulfur, the other harmful and inflammable gas is generated. Toxic gas would flow into the room and it would cause serious damage to user's health and safety (some poisoning or deficiency of oxygen). In addition, it may cause corrosion of heat exchanger and bad smell.
- Connect the pipe securely to avoid water leakage from the joint.
- Insulate the pipe properly to avoid condensation drop.
- Check if the water can flow out properly from both the drain outlet on the indoor unit and the end of the drain pipe after installation.
- Make sure to make descending slope of greater than 1/100 and do not make up-down bend and/or trap in the midway. In addition, do not put air vent on the drain pipe. Check if water is drained out properly from the pipe during commissioning. Also, keep sufficient space for inspection and maintenance.

Work procedure

- Make sure that the drain hose (the soft PVC side) is inserted into the end of the step part of the drain socket. Fix the hose clamp so that its bolt is located on the outside of the indoor unit, and the bolt are fastened in a vertical orientation.
 - Do not apply adhesives on this end.
- Position the hose clamp so that it touches the insulation of the drain hose, and then tighten the bolt.
- Turn the bolt several times until it is securely tightened, but do not tighten it excessively.

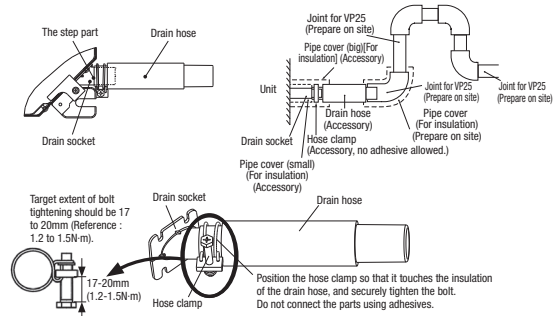

- Prepare a joint for connecting VP25 pipe, adhere and connect the joint to the drain hose (the rigid PVC side), and adhere and connect VP25 pipe (prepare on site).
 - ※ As for drain pipe, apply VP25 made of rigid PVC which is on the market.
 - Make sure that the adhesive will not get into the supplied drain hose. It may cause the flexible part broken after the adhesive is dried up and gets rigid.
 - The flexible drain hose is intended to absorb a small difference at installation of the unit or drain pipes. Intentional bending, expanding may cause the flexible hose broken and water leakage.
 - As for drain pipe, apply VP25 (OD32). If apply PVC25 (OD25), connect the expanded connector to the drain hose, with adhesive. (Multi unit only)

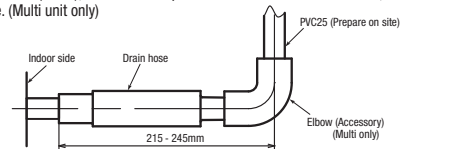

- Make sure to make descending slope of greater than 1/100 and do not make up-down bend and/or trap in the midway.
 - Pay attention not to give stress on the pipe on the indoor unit side, and support and fix the pipe as close place to the unit as possible when connecting the drain pipe.
 - Do not set up air vent.

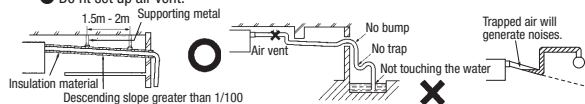

⑥ Drain pipe (continued)

- When sharing a drain pipe for more than 1 unit, lay the main pipe 100mm below the drain outlet of the unit. In addition, select VP30 or bigger size for main drain pipe.

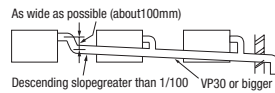

6. Insulate the drain pipe.

- Be sure to insulate the drain socket and rigid PVC pipe installed indoors otherwise it may cause dew condensation and water leakage.
- ※ After drainage test implementation, cover the drain socket part with pipe cover (small size), then use the pipe cover (big size) to cover the pipe cover (small size), clamps and part of the drain hose, and fix and wrap it with tapes to wrap and make joint part gasless.

Drain up

- The position for drain pipe outlet can be raised up to 850mm above the ceiling. Use elbows for installation to avoid obstacles inside ceiling. If the horizontal drain pipe is too long before vertical pipe, the backflow of water will increase when the unit is stopped, and it may cause overflow of water from the drain pan on the indoor unit. In order to avoid overflow, keep the horizontal pipe length and offset of the pipe within the limit shown in the figure below.

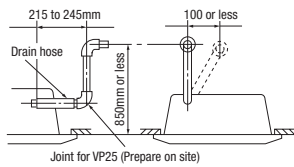

Drain test

- After installing the drain pipe, make sure that drain system works correctly and that no water leaks from the joint and drain pan. Check whether the motor sound of the drain pump is normal.
- Conduct a drain test when installing, even during the heating season.
- In the case of new buildings, be sure to complete the test before fixing the ceiling.

1. Pour about 1,000 cc of test water into the drain pan of the indoor unit. Exercise care not to allow electrical equipment such as the drain pump and other components to become wet while filling water. Pour test water through the pipe lid using a feed water pump or a similar device, or through the refrigerant pipe joint.

- In case of pouring water from the air outlet

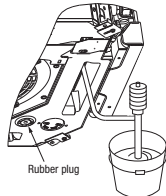

- In case of pouring water from the pipe lid

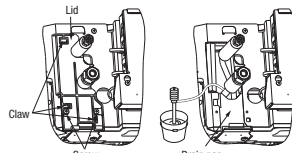

2. Make sure that water drains out completely and that no water leaks from any joints of the drain pipe during the test. Test to confirm that the water drains out correctly while listening to the drain pump motor operating sound. At the drain socket (transparent), it is possible to check whether the water drains out correctly.
3. Unplug the rubber plug on the indoor unit so that the remaining water drains from the drain pan after the draining test. After checking the water drainage, fix the rubber plug correctly. Installation work for the drain pipe must be performed for the entire drain pipe up to the indoor unit. If the pipe lid has been removed in order to pour water, mount the pipe lid again.

Drain pump operation

- In case electrical wiring work completed
Drain pump can be operated by the wired remote control. For the operation method, refer to [Operation for drain pump] in the installation manual for wiring work.
- In case electrical wiring work not completed
Drain pump will run continuously when the dip switch "SW7-1" on the indoor unit PCB is turned ON, the connector CnB is disconnected, and then the power source (230VAC on the terminal block ① and ②) is turned ON. Make sure to turn OFF "SW7-1" and reconnect the connector CnB after the test.

⑦ Wiring-out position and wiring connection

- Electrical installation work must be performed according to the installation manual by an electrical installation service provider qualified by a power provider of the country, and be executed according to the technical standards and other regulations applicable to electrical installation in the country.
 - Be sure to use an exclusive circuit.
 - Use specified cord, fasten the wiring to the terminal securely, and hold the cord securely in order not to apply unexpected stress on the terminal.
 - Do not put both power source line and signal line on the same route. It may cause miscommunication and malfunction.
 - Be sure to do D type earth work.
 - For the details of electrical wiring work, see attached instruction manual for electrical wiring work.
1. Loosen screws (2 pcs.) on the control box of the unit.
 2. Remove the control lid by sliding it in the arrow direction in the figure.
 3. Introduce the wiring in the control box, and connect it securely to the terminal block.
 4. Fix the wiring with bands as shown below.
 5. Install the control lid, with care not to pinch the wiring, and fix the lid with screws (2 pcs.).

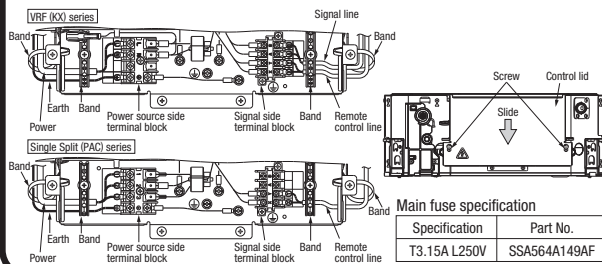

⑧ Panel installation

- Install the panel on the indoor unit after electrical wiring work.
- Refer to the attached manual for panel installation for details.

⑨ Check list after installation

- Check the following items after all installation work completed.

Check if;	Expected trouble	Check
The indoor and outdoor units are fixed securely?	Falling, vibration, noise	
Inspection for leakage is done?	Insufficient capacity	
Insulation work is properly done?	Water leakage	
Water is drained properly?	Water leakage	
Power source voltage is same as mentioned in the model name plate?	PCB burnt out, not working at all	
There is mis-wiring or mis-connection of piping?	PCB burnt out, not working at all	
Earth wiring is connected properly?	Electric shock	
Cable size comply with specified size?	PCB burnt out, not working at all	
Any obstacle blocks airflow on air inlet and outlet?	Insufficient capacity	

⑩ How to check the dirt of drain pan and cleaning the inlet of the drain pump. (Maintenance)

The method of checking the dirt of drain pan

1. Remove the panel according to the installation manual of the panel.
2. Check the dirt on the drain pan from the drain cap, and check the drain pump inlet. If the drain pan is very dirty, remove the drain pan and clean it.

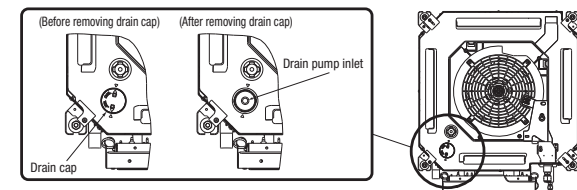

Cleaning of drain pump inlet

- It is possible to clean the drain pump inlet and surrounding area by removing the drain cap only; it is not necessary to remove the drain pan.
 - Before removing the drain cap, remove the rubber plug and drain water from the drain pan.
1. Insert the nose of the pliers into the concave portions (2 places) of the drain cap, and rotate the pliers about 1 turn in the CCW direction. The drain cap is removed.
 2. When cleaning the drain pump inlet, use a soft plastic tool. If a metallic tool is used, the drain cap mounting portion may be scratched and water may leak.
 3. Before mounting the drain cap, rinse it and **remove any foreign material from the inside of the cap**. If the drain cap is installed with foreign material inside it, it may cause water to leak.
 4. Insert the nose of the pliers into the concave portions of the drain cap and rotate the pliers to install the drain cap. Rotate the drain cap about 1 turn in the CW direction until it stops rotating. If the drain cap is not rotated for 1 or more turns, the cap will not have been installed correctly. Remove the drain cap, and then install it again correctly.
 5. After tightening the drain cap, make sure the triangle (▲) mark of the drain cap comes close to the triangle mark on the drain pan. If these triangle marks are not close to each other, tighten the drain cap further.
 6. Refix the rubber plug securely. If the cover is not refixed correctly, it may cause condensation to form and/or water to leak.

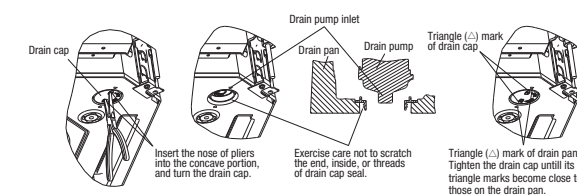

Notes for removing the drain pan

- Before removing the drain pan, drain water from the drain pan. Remove the rubber plug and drain water.
- The drain pan is installed by the temporary installation plate. Remove the 2 drain pan fixing screws, and loosen the 2 screws of the temporary installation plate. Slide the temporary installation plate to the outside of the drain pan. And then, it is possible to remove the drain pan.
- When reinstalling the drain pan, slide the temporary installation plate to the inside and temporarily fix the drain pan. Then, tighten the 2 drain pan fixing screws and the 2 screws of the temporary installation plate. Also, refix the rubber plug securely.

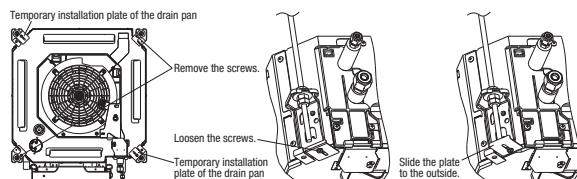

4. INSTALLATION OF PANEL

PJF012D503

Read this manual together with the indoor unit's installation manual.

* Caution before use

- ① Be careful the installation height when installing the indoor unit. Also note that the installation height of this indoor unit is different from that of current (old) unit.

Installation height from the ceiling surface to the indoor unit.
 • Old unit: 30 mm ⇒ This unit: 35 $\frac{1}{2}$ mm

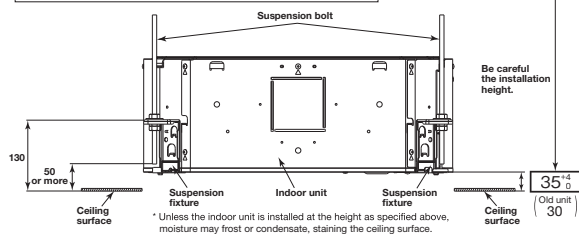

- ② Do not attempt to move forcibly the louver and the air flex.

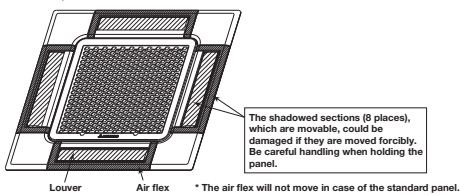

WARNING

- Fasten the wiring to the terminal securely and hold the cable securely so as not to apply unexpected stress on the terminal. Loose connection or hold will cause abnormal heat generation or fire.
- Make sure the power source is turned off when electric wiring work. Otherwise, electric shock, malfunction and improper running may occur.

Function

The draft prevention panel has the draft prevention mechanism. If the draft prevention panel is installed and the draft prevention function is set, the draft prevention function will be operated and reduce the draft feeling. (Refer to **⑩ Panel setting** for details.)

- Standard panel : without the draft prevention mechanism
- Draft prevention panel : with the draft prevention mechanism

① Before installation

- Follow installation manual carefully, and install the panel properly.
- Check the following items.
- Accessories

Accessories

Bolt	4 pieces	For panel installation
Strap	4 pieces	For avoiding the corner panel from falling
Grille hook	1 piece	For avoiding the grille from falling
Screw	4 pieces	For fixing the corner panel

Note: Accessories are laid in the position removing the corner lid.

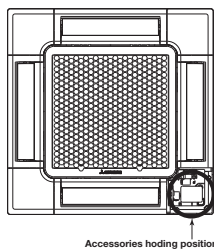

② Checking the indoor unit installation height

- Read this manual together with the air-conditioner installation manual carefully.
- Check if the opening size for the indoor unit is correct with the level gauge supplied in the indoor unit.
- Check if the gap between the plane and the indoor unit is correct by inserting the level gauge into the air outlet port of the indoor unit. (See below drawing)
- Adjust the installation elevation if necessary.
- Remove the level gauge before installing the panel.

Caution
 If there is a height difference beyond the design limit between the installation level of the indoor unit and the panel, the panel may be subject to excessive stress during installation and it may cause distortion and damage.

<In case of other than the system ceiling>

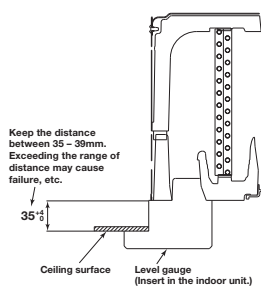

<In case of the system ceiling>

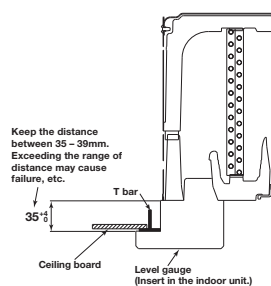

③ Removing the inlet grille

1. While placing a finger behind the stopper (2 places) and pressing it in the direction of arrow ①, pull the grille downward to open the grille.
2. Release the hooks of the inlet grille from the panel while it is in the open position.

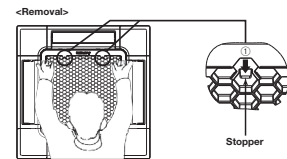

④ Removing the corner lid

- Pull the corner lid toward the direction indicated by the arrow and remove it. (Same way for all 4 corner lids)

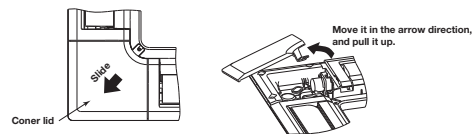

⑤ Before installing the panel <Only Draft prevention panel>

- ① Loosen screws (2 pcs.) on the control lid of the unit.
- ② Slide the control lid in the arrow direction in the figure, and remove it.
- ③ Loosen screws on the wiring cover (2 places).
- ④ Slide the wiring cover (2 places) in the arrow direction in the figure, and remove it.
- ⑤ Disconnect the relay connector of the air flex motor wiring attached to the panel.
- ⑥ Connect the air flex motor wiring to CNJ2 (20 P, gray) on PCB in the control box of the unit.
- ⑦ Pass the air flex motor wiring as shown in the figure.
- ⑧ Install the wiring cover (1 place) with care not to pinch wiring, and fix it with a screw.
- ⑨ Fix the air flex motor wiring with a band as shown in the figure.
- ⑩ Install the control lid with care not to pinch wiring, and fix with screws (2 places.).

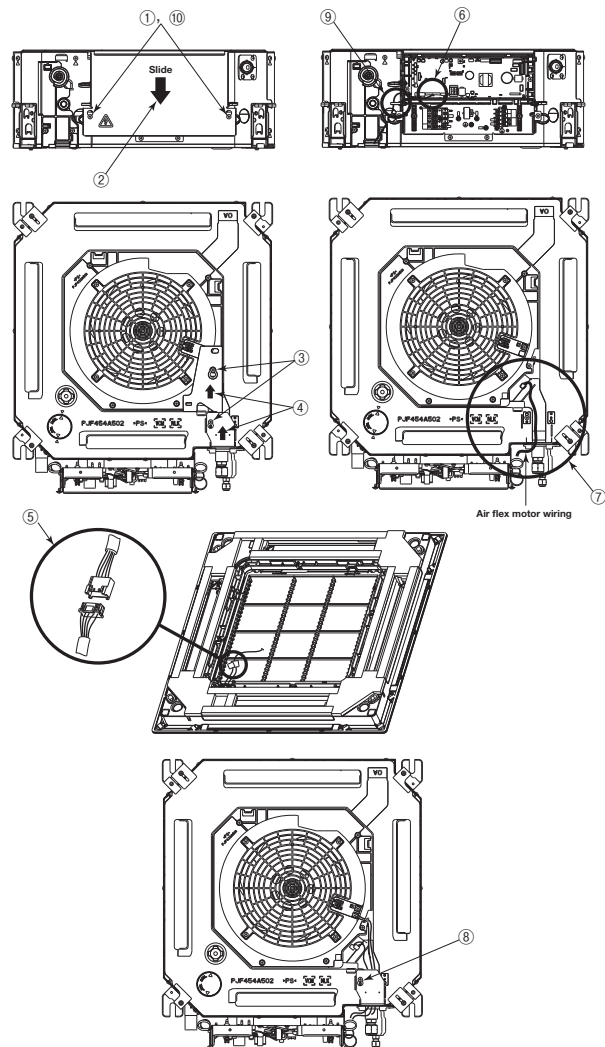

⑥ Orientation of the panel installation

- Take note that there is an orientation to install the panel.
- Install the panel with the orientation shown on the right.
 - Align the "PIPE SIDE" mark (on the panel) with the refrigerant pipes on the indoor unit.
 - Align the "DRAIN" mark (on the panel) with the drain pipe on the indoor unit.

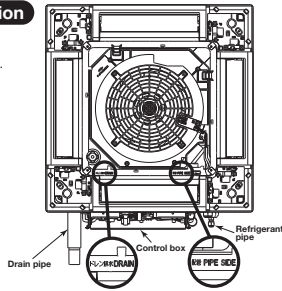

CAUTION

In case the orientation of the panel is not correct, it will lead to air leakage and also it is not possible to connect the motor wiring.

⑦ Installing the panel

1. Temporary hanging

- Lift up the hanger (2 places) on the panel for temporary support.
- Hang the panel on the hook on the indoor unit.

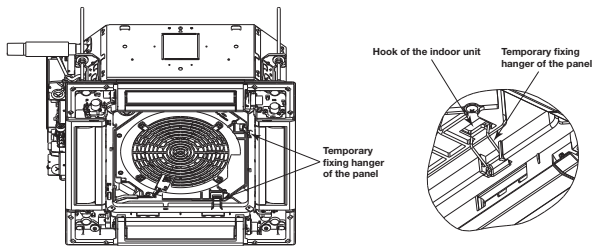

2. Fix the panel on the indoor unit

- Fasten the panel on the indoor unit with the 4 bolts supplied with the panel.

Caution

Be careful not to pinch the motion sensor wiring.

Caution

• Improperly tightened fixing bolts cause the problems listed below, so make sure that bolts are securely tightened.

• If there is a gap between the ceiling and the panel even after the fixing bolts are tightened, adjust the installation level of the indoor unit again.

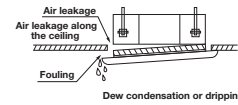

Bolt for installing the panel

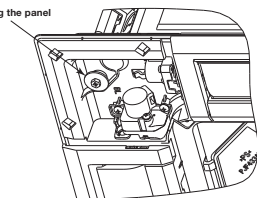

Caution

Do not give any stress on the panel when adjusting the height of the indoor unit to avoid unexpected distortion. It may cause the distortion of panel or failing to close the inlet grille, and the parts of the draft prevention mechanism.

⑧ Electrical wiring

The wiring work varies depending on the panel type. Select the wiring work appropriate for the panel type.

<For the standard panel>

- ① Connect the connector of the lower motor wiring (Wiring color: Red, Black) at the panel side to the connector CnJ3 (20 P, White) of the lower motor wiring (Wiring color: Red, Black) at the unit side.

For the Standard panel

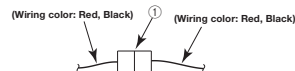
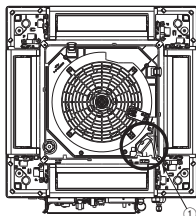

<For the draft prevention panel>

- ① Connect the connector of the lower motor wiring (Wiring color: Red, Black) at the panel side to the connector CnJ3 (20 P, White) of the lower motor wiring (Wiring color: Red, Black) at the unit side.
- ② Connect the connector of the air flex motor wiring (Wiring color: Blue, White) at the panel side to the connector CnJ4 (20 P, White) of the air flex motor wiring (Wiring color: Blue, White) at the unit side.

For the Draft prevention panel

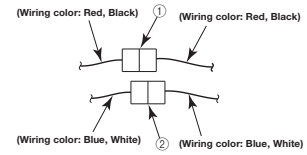
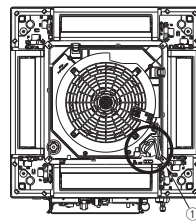

Motor wiring connection - Detail view

Install the wiring cover with care not to pinch wiring, and fix it with screws.

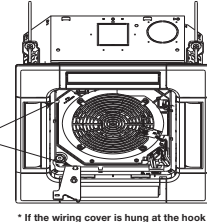
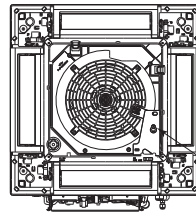

* If the wiring cover is hung at the hook on panel, it will become easier to work.

⑨ Installing a corner lid

1. To avoid unexpected falling of the corner lid, put the strap onto the corner lid's pin with turning the strap up.
2. Then hang the strap of a corner lid onto the panel's pin.
3. Hook the corner lid claws at 3 places, and fix the corner lid with attached screws.

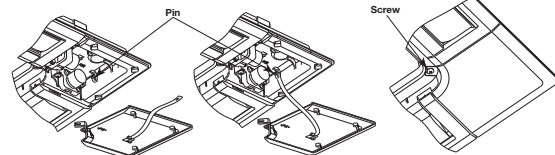

⑩ Installing the inlet grille

The panel and the inlet grille have no directional limitation to install. (Hinges of the inlet grille can be hooked at any side.)

Install the inlet grille in the reverse order of the steps described at **④ Removing the inlet grille**.

- ① Attach the fall grille hook to the panel.
- ② Insert the hinges of inlet grille in the insert holes on the panel. Close then the inlet grille while pressing the stoppers (2 places). Confirm that both stoppers are inserted securely in the panel.

<① Installation of the grille hook>

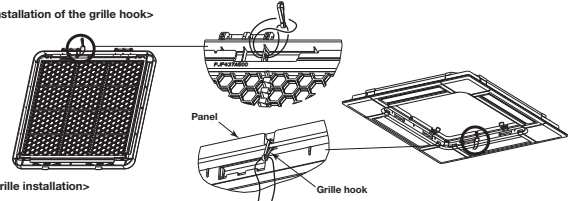

<② Grille installation>

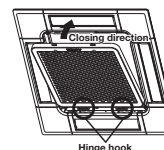

Caution

- Install the grille hook securely at the panel.
- The inlet grille must be installed starting from the hinge side.
- Install the inlet grille securely. It may drop if it is installed insecurely.
- When the stoppers have been deformed or damaged, repair them immediately. Unless they are repaired properly, the inlet grille may drop off.

⑪ Panel setting

<Louver swing range setting (Individual louver control setting)>

It is possible to change the swing range of the louver by the wired remote control. Once the upper and lower limit positions are set, the louver will swing within the set range. It is also possible to set the different range to each louver.

<Draft prevention setting>

The draft prevention function will not be operated if the draft prevention panel is installed and its wirings are only connected. To operate the draft prevention function, enable the draft prevention setting by using the wired or wireless remote control.

Note: It is not possible to set by the following remote control models or older.

- Wired: RC-EX3, RC-E5, RCH-E3
- Wireless: RCN-E1R

Once you have enabled the settings in this mode, the draft prevention function is operated when the air-conditioner is started, and the parts of the draft prevention mechanism are always open when the air-conditioner is operating. When the air-conditioner is stopped, they are closed. It is possible to enable or disabled the draft prevention function for each air outlet.

For the setting details, refer to the user's manual supplied with the remote control.

FRESH AIR INTAKE (Location for installation) FOR FDTC

At the time of installation use the duct hole (cut out) located at the positions shown in following diagram, as and when required.

(1) Temperature conditions for OA spacer⁽¹⁾

- Adjust the temperature conditions of mixed air with outdoor air and indoor air within the usage range of suction air temperature for the air-conditioner.
- The usage temperature conditions of intake outdoor air and indoor air around the ducts are shown in the following table.
- If the temperature conditions of intake outdoor air do not satisfy, process the outdoor air before intaking.

Operation mode	Usage temperature conditions	
	Intake outdoor air	Indoor air around the ducts
In heating	5°C DB or higher	18.5°C WB or lower and 60% RH or lower
In cooling	29°C DB or lower and 80% RH or lower	20°C DB or higher

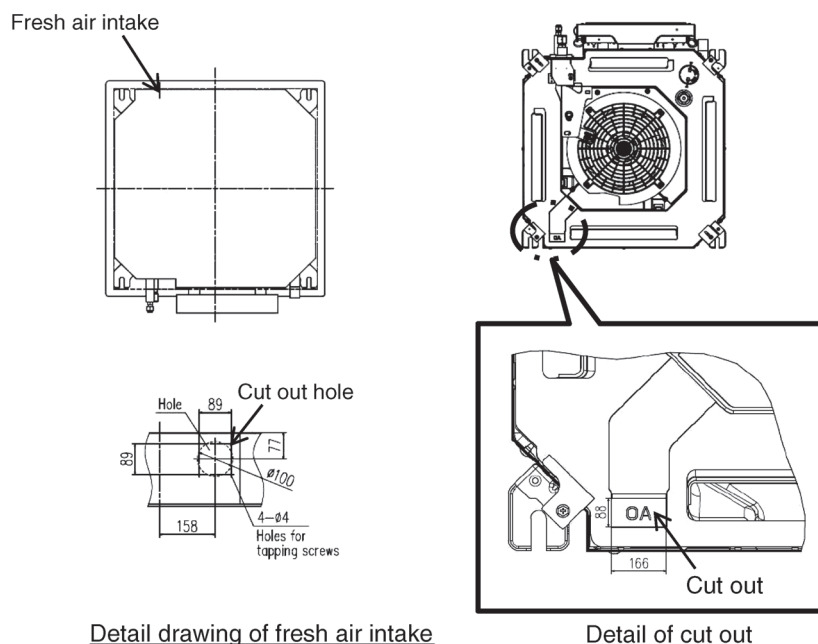

■ Fresh air intake amount & static pressure characteristics

All models

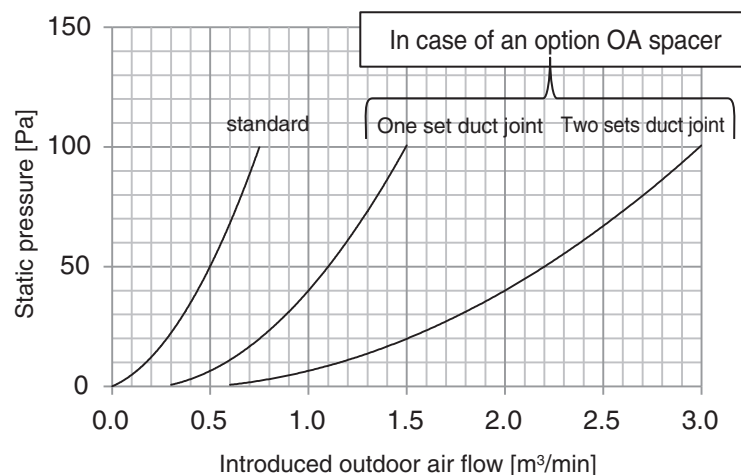

CHARACTERISTICS OF AIR FLOW IN DIVIDED DUCT FOR FDTC

Models **FDTC25,35,40VH**
FDTC15,22,28,36KXZE1

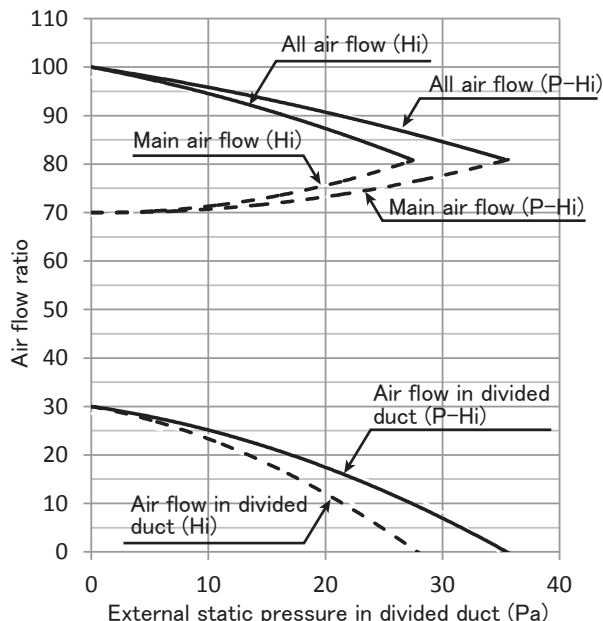
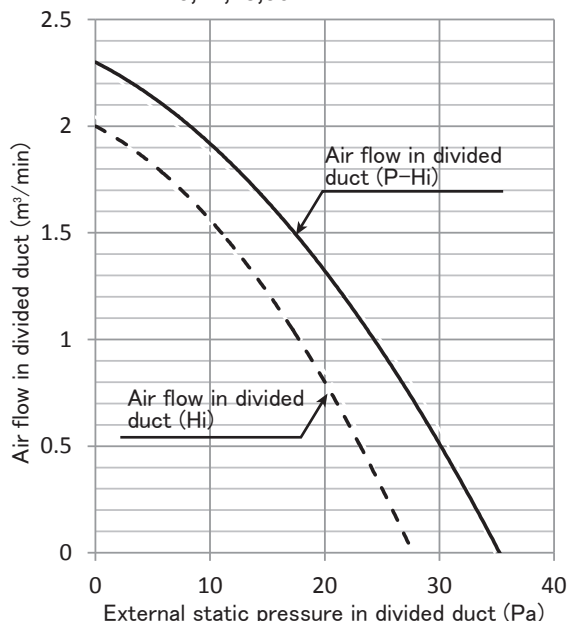

Models **FDTC50,60VH**
FDTC45,56KXZE1

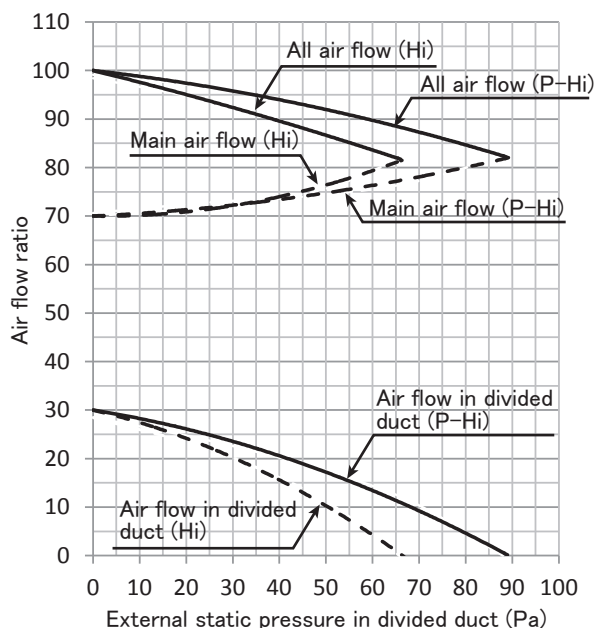
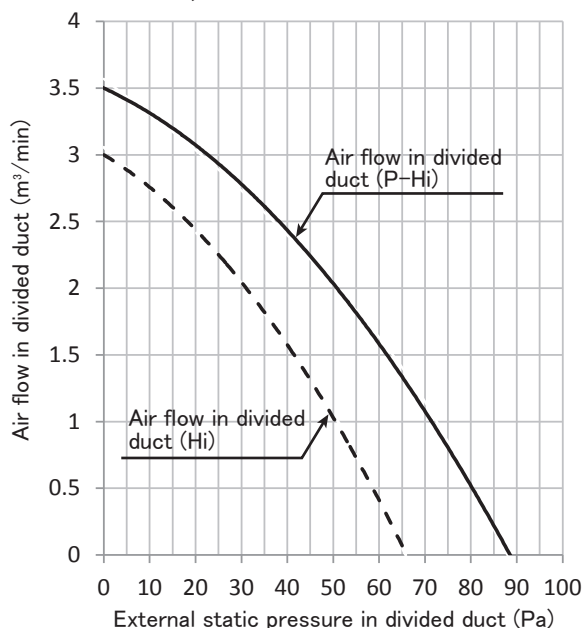

■ Divided duct connection method

1. Open some one during 4 knockout holes, and please connect a divided duct.

It isn't possible to use more than one hole at the same time.

2. Please make the wind shielding a blowout vent on the side where a divided duct was connected.
3. The storage of the external static pressure by pressure loss for a connected divided duct and blowout unit is made up by a booster fan.
example : When 2.5m³/min of ventilation by divided duct is needed in model FDTC60VH

(In case of connection duct $\phi 125 \times 5m$)

- ① Duct resistance : Pressure loss by a flexible duct =35Pa (7Pa/mx5m)
- ② Blowout unit : Pressure loss by a blowout unit =10Pa
- ③ External static pressure when being 2.5m³/min =17Pa (See upper table.)

⇒Correspondence by a booster fan =①+②-③ =28Pa

5. WIRELESS KIT

FDTC series(RCN-TC-5AW-E3)

(1) Specification

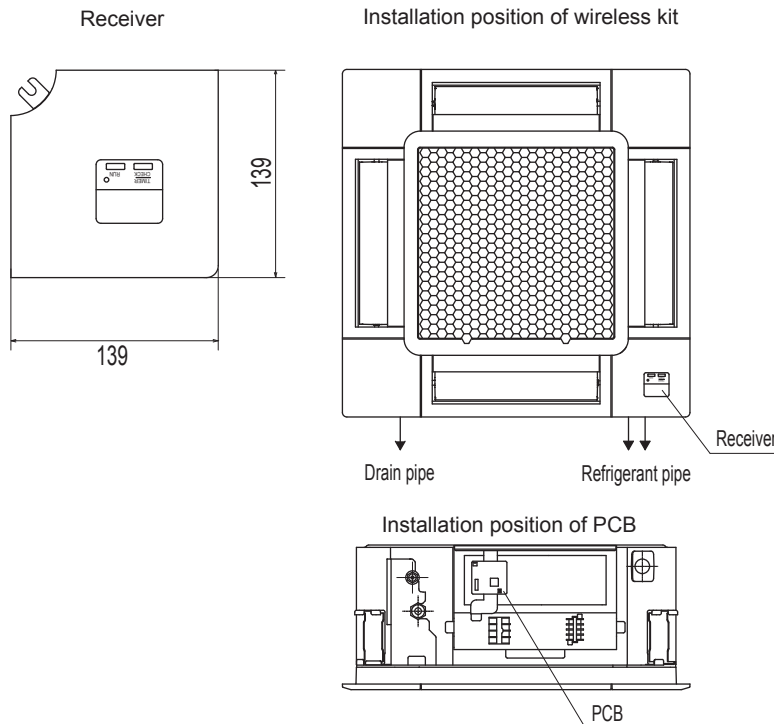

- Notes**
- (1)Receiver must be installed to the position as shown.
 - (2)Two LR03 AAA dry cell batteries for remote control are enclosed.
 - (3)See spec sheet of "Wireless remote control" about remote control.

Installation of wireless kit

Do not install the wireless kit at the following places in order to avoid malfunction.

- (1)Places exposed to direct sunlight
- (2)Places near heat-generating devices
- (3)High humidity places
- (4)Hot surface or cold surface enough to generate condensation
- (5)Places exposed to oil mist or steam directly
- (6)Uneven surface
- (7)Places affected by the direct airflow of the AC unit
- (8)Places where the receiver is influenced by fluorescent lamp or sunlight
- (9)Places where the receiver is affected by infrared rays of any other communication devices
- (10)Places where some object may obstruct the communication with the remote control

Setting switch on PCB

SW1	Prevents interference during multiple setting	ON:Normal OFF:Remote
SW2	Receiver master/slave setting	ON:Master OFF:Slave
SW3	Buzzer	ON:Valid OFF:Invalid
SW4	Auto restart	ON:Valid OFF:Invalid

Default setting: mark

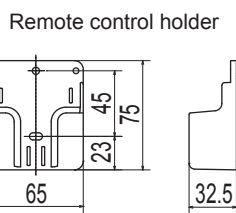
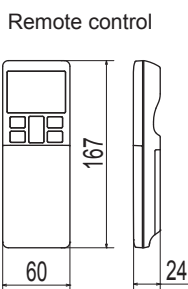

Wireless remote control's operable area

- ① Standard reachable area of the signal
[condition] Illuminance at the receiver:300lux
(When no lighting is installed within 1m of the receiver in an ordinary office)

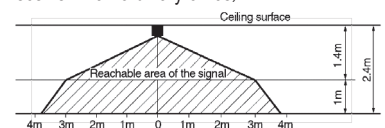

- ② Correlation between illuminance at the receiver and reachable area of the signal in a plain view.
The drawing in the right shows the correlation between the reachable area of the signal and illuminance at the receiver when the remote control is operated at 1m high under the condition of ceiling height of 2.4m.
When the illuminance becomes double, the area is narrowed down to two thirds.

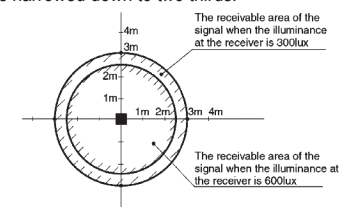

- ③ Installation tips when several receivers are installed close to one another Minimum distance between the indoor units which can avoid cross communication is 5m under the condition of 300lux of illuminance at the receiver.
(When no lighting is installed within 1m of the receiver in an ordinary office)

Unit:mm

PJF000Z634

(2) Installation manual

PJF012D506B

Safety precautions

• Please read this manual carefully before starting installation work to install the unit properly. All of the following are important information to be observed strictly.

⚠ WARNING Failure to follow these instructions properly may result in serious consequences such as death, severe injury, etc.













⚠ CAUTION Failure to follow these instructions properly may cause injury or property damage. It could have serious consequences depending on the circumstances.

• The following symbols are used in the text.

	Never do.		Always follow the instructions given.
---	-----------	---	---------------------------------------

• Keep this manual at a safe place where you can consult with whenever necessary. Show this manual to installers when moving or repairing the unit. When the ownership of the unit is transferred, this manual should be given to the new owner.

⚠ WARNING

-  • **Consult your dealer or a professional contractor to install the unit.**
Improper installation made on your own may cause electric shocks, fire or dropping of the unit.
-  • **Installation work should be performed properly according to this installation manual.**
Improper installation work may result in electric shocks, fire or break-down.
-  • **Be sure to use accessories and specified parts for installation work.**
Use of unspecified parts may result in drop, fire or electric shocks.
-  • **Install the unit properly to a place with sufficient strength to hold the weight.**
If the place is not strong enough, the unit may drop and cause injury.
-  • **Be sure to have the electrical wiring work done by qualified electrical installer, and use exclusive circuit.**
Power source with insufficient and improper work can cause electric shock and fire.
-  • **Shut OFF the main power source before starting electrical work.**
Otherwise, it could result in electric shocks, break-down or malfunction.
-  • **Do not modify the unit.**
It could cause electric shocks, fire, or break-down.
-  • **Be sure to turn OFF the power circuit breaker before repairing/inspecting the unit.**
Repairing/inspecting the unit with the power circuit breaker turned ON could cause electric shocks or injury.
-  • **Do not install the unit in appropriate environment or where inflammable gas could generate, flow in, accumulate or leak.**
If the unit is used at places where air contains dense oil mist, steam, organic solvent vapor, corrosive gas (ammonium, sulfuric compound, acid, etc) or where acidic or alkaline solution, special spray, etc. are used, it could cause electric shocks, break-down, smoke or fire as a result of significant deterioration of its performance or corrosion.
-  • **Do not install the unit where water vapor is generated excessively or condensation occurs.**
It could cause electric shocks, fire, or break-down.
-  • **Do not use the unit in a place where it gets wet, such as laundry room.**
It could cause electric shocks, fire, or break-down.
-  • **Do not operate the unit with wet hands.**
It could cause electric shocks.

⚠ WARNING

- **Do not wash the unit with water.**
It could cause electric shocks, fire, or break-down.
- **Use the specified cables for wiring, and connect them securely with care to protect electronic parts from external forces.**
Improper connections or fixing could cause heat generation, fire, etc.
- **When installing the unit at a hospital, telecommunication facility, etc., take measures to suppress electric noises.**
It could cause malfunction or break-down due to hazardous effects on the inverter, private power generator, high frequency medical equipment, radio communication equipment, etc. The influences transmitted from the remote control to medical or communication equipment could disrupt medical activities, video broadcasting or cause noise interference.
- **Do not leave the remote control with its PCB case removed.**
If dew, water, insect, etc. enter through the hole, it could cause electric shocks, fire or break-down.

⚠ CAUTION

- Do not install the wireless kit at the following places in order to avoid malfunction. It could cause break-down or deformation of remote control.

(1) Places exposed to direct sunlight (2) Places near heat-generating devices (3) High humidity places (4) Hot surface or cold surface enough to generate condensation (5) Places exposed to oil mist or steam directly (6) Uneven surface (7) Places affected by the direct air flow of the AC unit	(8) Places where the receiver is influenced by fluorescent lamp (especially inverter type) or sunlight (9) Places where the receiver is affected by infrared rays of any other communication devices (10) Places where some object may obstruct the communication with the remote control
--	---

① Accessories

Please make sure that you have all of the following accessories.

① Receiver		1	⑤ Bracket mounting screw		1
② PCB		1	⑥ Wiring (For communication)		1
③ PCB mounting support		2	⑦ Wiring (For receiving)		1
④ Bracket (Sheet metal)		1	⑧ Installation manual		1
			⑨ Parts set		1

① Wireless remote control (RCN-E2)		1
② Remote control holder		1
③ Screw for holder		2
④ AAA dry cell battery (LR03)		2
⑤ User's manual		1

② Preparation before installation

Setting of PCB

Accessory PCB has the following switches to set the functions. Default setting is shown with mark.

SW1	Prevents interference during multiple setting	<input type="checkbox"/> ON : Normal	<input type="checkbox"/> OFF : Remote
SW2	Receiver master/slave setting	<input type="checkbox"/> ON : Master	<input type="checkbox"/> OFF : Slave
SW3	Buzzer	<input type="checkbox"/> ON : Valid	<input type="checkbox"/> OFF : Invalid
SW4	Auto restart	<input type="checkbox"/> ON : Valid	<input type="checkbox"/> OFF : Invalid

② Preparation before installation (continued)

To change setting

1. Change the setting of switches on the accessory PCB.

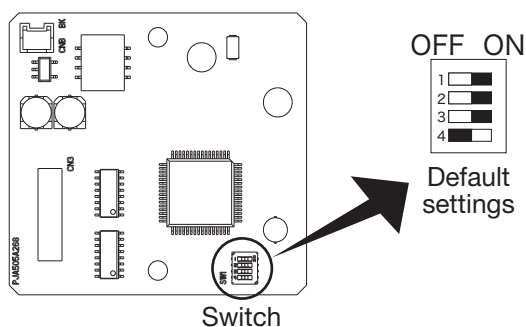

Master/Slave setting when using multiple remote controls

Up to two receivers or wired remote controls can be installed on one indoor unit group. In such occasion, it is necessary to change the setting to slave on either one.

To change the setting on the receiver, refer to the instruction manual of the receiver.

2. When SW1 is turned to OFF position, change the wireless remote control setting.

For the method of changing the setting, refer to **Setting to avoid mixed communication** of

④ Wireless remote control.

*For the receivable area of the signal, refer to **⑤ Receiver**.

③ How to install the receiver

It is possible to install the receiver by replacing the corner lid on the panel.

Preparation before installation

- ① Remove the inlet grille according to the installation manual of the panel.
- ② Remove the corner lid at the refrigerant pipe side.
- ③ Loosen screws (2 pcs.) on the control box of the unit.
- ④ Slide the control lid in the arrow direction, and remove it.

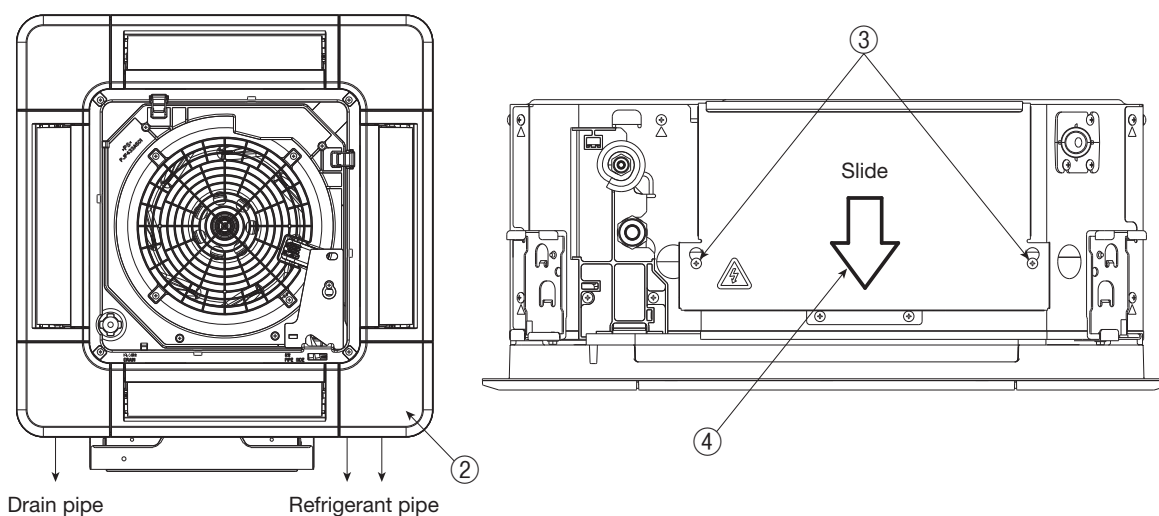

③ How to install the receiver(continued)

Installation of the receiver

- ① Connect the wire connector (Communication) to CNB on PCB.
- ② Connect the wire connector (Receiver) to CN3 on PCB.
- ③ Install the PCB mounting supports on the bracket (Sheet metal).
- ④ Install PCB on the PCB mounting supports.
- ⑤ Insert the bracket (Sheet metal) in one side of control box, and fix the other side with screws as shown in the figure.
- ⑥ Connect round terminals of wires (Communication) to the terminal block (X, Y) in the control box. The wires have no polarity.
- ⑦ Fix wires with bands as shown in the figure.
- ⑧ Cut off the half-blanks on the panel (at 4 places) as shown in the figure.
- ⑨ Pass the wiring (Communication) through the opening on the panel.
- ⑩ Connect connectors of the wiring (Communication) and the receiver.
- ⑪ Install the receiver on the panel according to the installation manual of the panel.
- ⑫ Install the control box lid with care not to pinch wires, and fix with screws (2 pcs.).

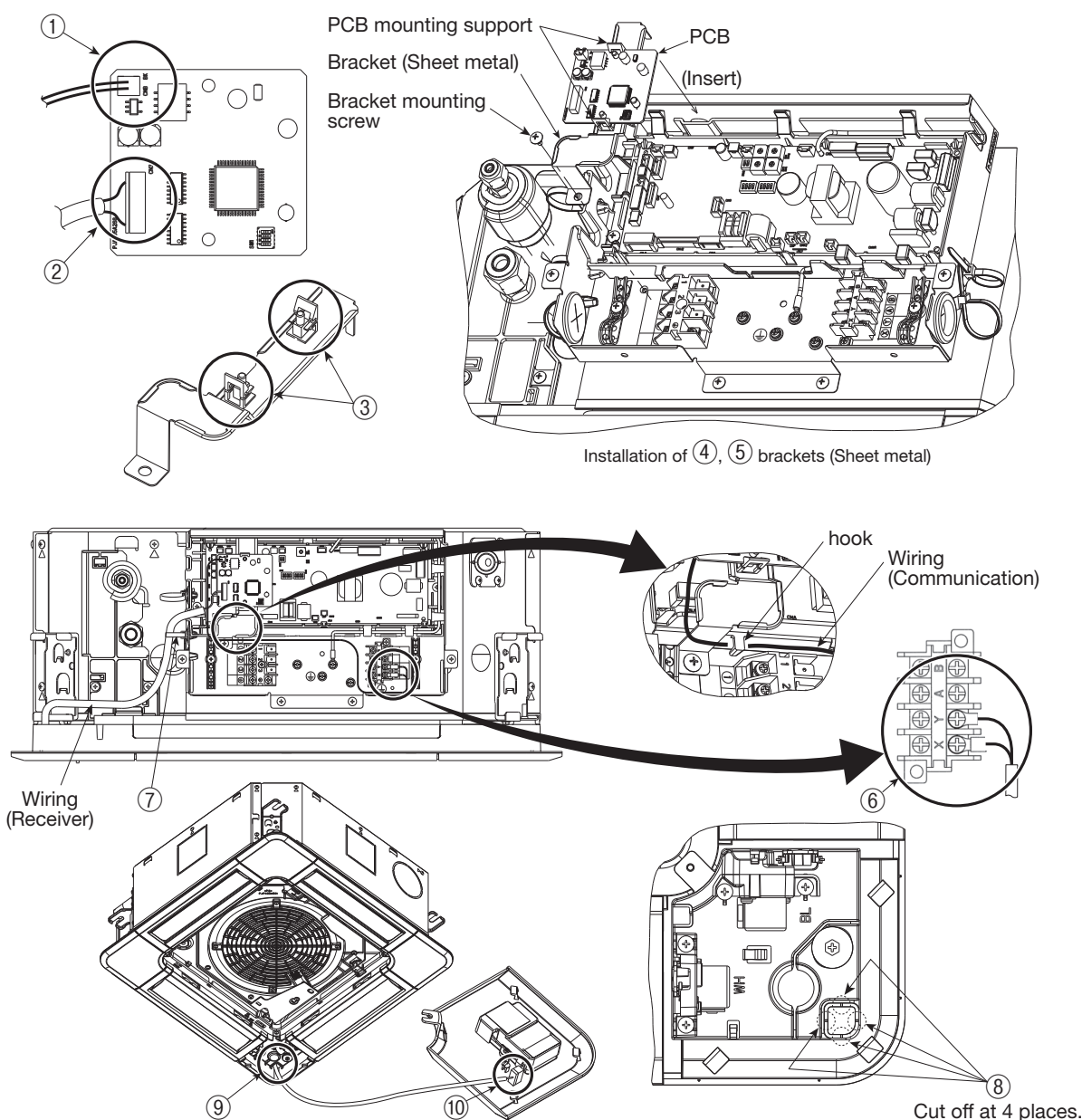

④ Wireless remote control

Installation tips for the remote control holder

Fix the remote control holder using the screws supplied with this product.

* Precautions for installing the holder

- Adjust the position so that it is upright.
- Ensure that the screw heads are not protruding.
- Do not attach the holder on plaster wall.

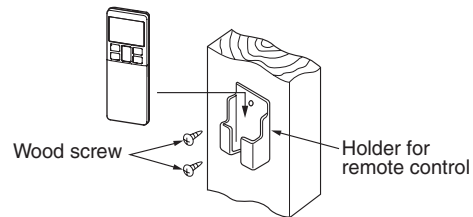

How to insert batteries

1. Detach the back lid.
2. Insert the batteries. (two AAA batteries)
3. Reattach the back lid.

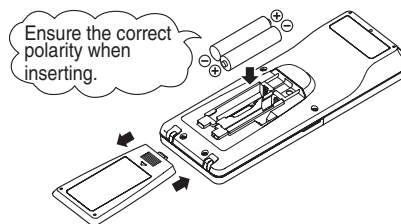

Setting to avoid mixed communication

1. Detach the back lid, and remove the batteries.
2. Cut off the switching wire in the battery compartment using nippers.
3. Insert the batteries, and attach the back lid.

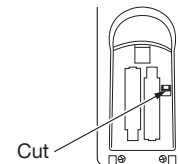

Changing the remote control setting

How to change the Auto Run setting

The Auto Run mode is not available on the building air-conditioning and gas heat pump series (excluding the cooling/heating free multi system).

When using the remote control to operate those models, set the remote control to disable the Auto Run mode.

To disable the Auto Run mode, press the **[ACL]** switch while holding down the **[MODE]** button, or insert batteries while holding down the **[MODE]** button.

* Note: Once the batteries are removed, the setting is reset to the factory default.
When the batteries are removed, repeat the steps described above.

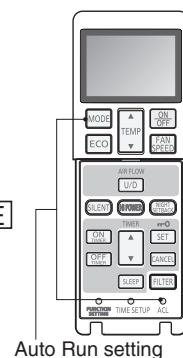

Indoor function settings

1. How to set indoor functions
 - ① Press the ON/OFF button to stop the unit.
 - ② Press the desired one of the buttons shown item 2. while holding down the FUNCTION SETTING switch.
 - ③ Use the selection buttons ▲ and ▼ to change the setting.
 - ④ Press the SET button.

The buzzer on the remote control signal receiver beeps twice, and the LED lamp flashes four times at two-second intervals.

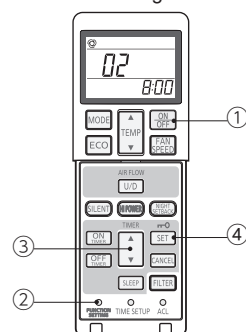

④ Wireless remote control (continued)

2. Setting details

The following functions can be set.

Button	Number indicator	Function setting
FAN SPEED	00	Fan speed setting : Standard
	01	Fan speed setting : Setting 1 *
	02	Fan speed setting : Setting 2 *
MODE	00	Room heating temperature adjustment : Disable
	01	Room heating temperature adjustment : +1°C
	02	Room heating temperature adjustment : +2°C
	03	Room heating temperature adjustment : +3°C
FILTER	00	Filter sign display : OFF
	01	Filter sign display : 180 hours
	02	Filter sign display : 600 hours
	03	Filter sign display : 1000 hours
	04	Filter sign display : Operation stop after 1000 hours have elapsed
U/D (Up/Down)	00	Anti draft setting : Disable
	01	Anti draft setting : Enable
SILENT	00	Infrared sensor setting (Motion sensor setting) : Disable
	01	Infrared sensor setting (Motion sensor setting) : Enable
HI POWER	00	Infrared sensor control (Motion sensor control) : Disable
	01	Infrared sensor control (Motion sensor control) : Power control only
	02	Infrared sensor control (Motion sensor control) : Auto OFF only
	03	Infrared sensor control (Motion sensor control) : Power control + Auto OFF
ON TIMER	00	Cooling fan residual-period running : Disable
	01	Cooling fan residual-period running : 0.5 hours
	02	Cooling fan residual-period running : 2 hours
	03	Cooling fan residual-period running : 6 hours
OFF TIMER	00	Heating fan residual-period running : Disable
	01	Heating fan residual-period running : 0.5 hours
	02	Heating fan residual-period running : 2 hours
	03	Heating fan residual-period running : 6 hours
NIGHT SETBACK	00	Remote control signal receiver LED : Brightness High
	01	Remote control signal receiver LED : Brightness Low
	02	Remote control signal receiver LED : OFF

* Refer to service manual.

5 Receiver

1 Control multiple indoor units with one remote control

Up to 16 indoor units can be connected.

1. Connect the XY terminal with 2 cores wire. As for the size, refer to the note on the right.
2. For Packaged air-conditioner series, set the indoor unit address with SW2 on the indoor unit PCB from [0] to [F] so as not to duplicate.

Restrictions on the thickness and length of wire (Maximum length is 600m.)

Standard	Within	0.3 mm ² × 100m
	Within	0.5 mm ² × 200m
	Within	0.75mm ² × 300m
	Within	1.25mm ² × 400m
	Within	2.0 mm ² × 600m

For the shop series

For VRF series, set the indoor unit address with SW1, SW2 and SW5-2 on the indoor unit PCB from [000] to [127] so as not to duplicate.

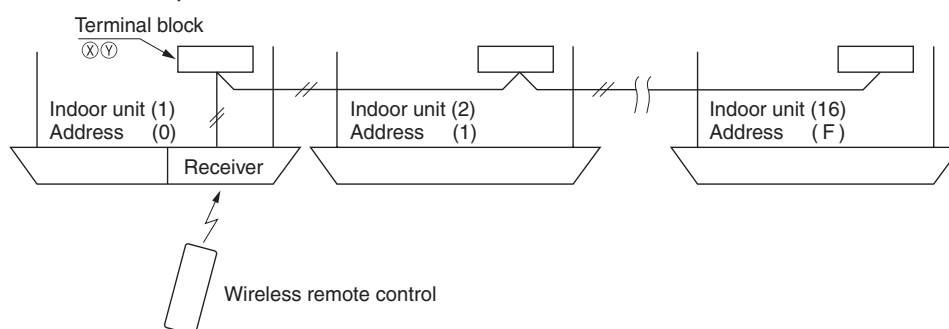

For the building air-conditioning and gas heat pump series

Set the indoor unit and outdoor unit numbers by manually specifying the addresses.

Use the rotary switches SW1 and SW2 provided on the indoor unit PCB (printed circuit board) to set the indoor unit numbers so that they are not duplicated.

Master/Slave setting when using multiple remote control

Up to two receivers can be installed in one indoor unit group.

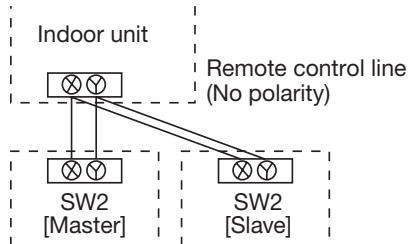

Switch	Setting	Function
SW2	ON	Master
	OFF	Slave

Wireless remote control's operable area

1. Standard reachable area of the signal

[Condition] Illuminance at the receiver: 300lux

(When no lighting is installed within 1m of the receiver in an ordinary office)

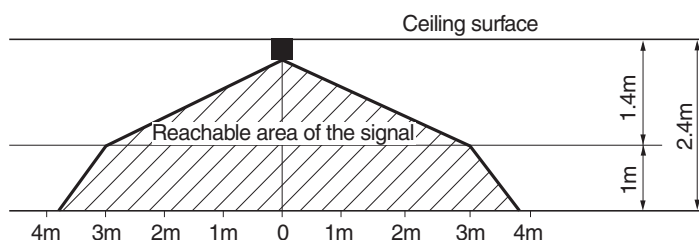

5 Receiver (continued)

2. Correlation between illuminance at the receiver and reachable area of the signal in a plain view.

The drawing in the right shows the correlation between the reachable area of the signal and illuminance at the receiver when the remote control is operated at 1m high under the condition of ceiling height of 2.4m. When the illuminance becomes double, the area is narrowed down to two thirds.

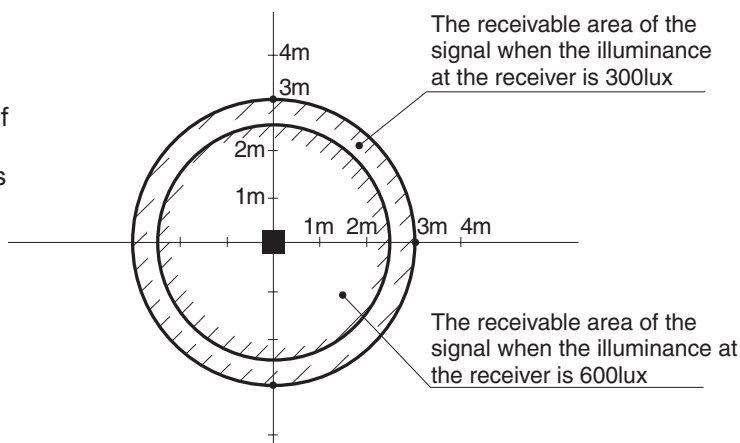

3. Installation tips when several receivers are installed close to one another.

Minimum distance between the indoor units which can avoid cross communication is 5m under the condition of 300lux of illuminance at the receiver.

(When no lighting is installed within 1m of the receiver in an ordinary office)

Backup switch

A backup switch is provided on the receiver section of the panel surface.

When operation from the wireless remote control unit is not possible (due to flat batteries, a mislaid unit, a unit failure), you can use it as an emergency means. You should operate this switch manually.

1. If pressed while the air-conditioner is in a halt, it will cause the air-conditioner to start operation in the automatic mode (In case of cooling only, it is in the cooling mode).
Wind speed: Hi fan, Temperature setting: 23°C, Louver: horizontal
2. If pressed while the air-conditioner is in operation, it will stop the air-conditioner.

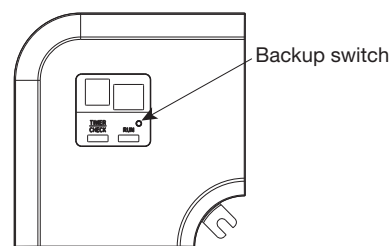

Cooling test run operation

- After safety confirmation, turn on the power.
- Transmit a cooling operation command with the wireless remote control unit, while the backup switch on the receiver is pressed.
- If the backup switch on the receiver is pressed during a test run, it will end the test run.
- If you cannot operate the unit properly during a test run, please check wiring by consulting with inspection guides.

How to read the two-digit display

On the receiver of a wireless kit, a two-digit (7-segment) display is provided.

1. An indication will be displayed for one hour after power on.
2. An indication will be displayed for 3.5 seconds after transmitting a "STOP" command from the wireless remote control or the operation of the backup switch to stop the unit.
3. An indication appearing in (1) or (2) above will go off as soon as the unit starts operation.
4. When there are no error records to indicate, addresses of all the connected units are displayed.
5. When there are some error records remaining, the error records are displayed.
6. Error records can be cleared by transmitting a "STOP" command from the wireless remote control, while the backup button is pressed.

6. MOTION SENSOR KIT

FDTC series(LB-TC-5W-E)

(1) Specification

Motion sensor kit

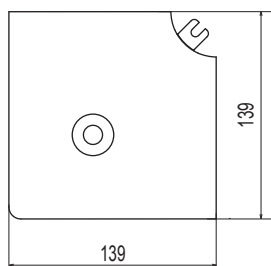

Installation position of motion sensor kit

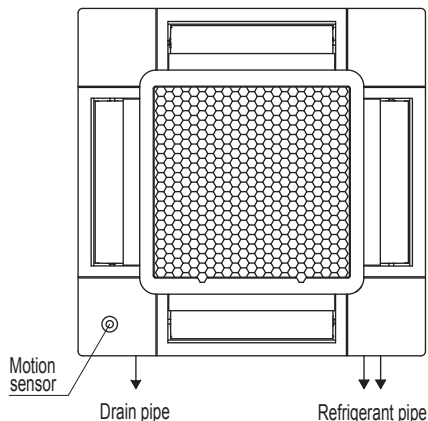

Note

(1) Motion sensor must be installed to the position as shown.

Installation of motion sensor kit

Do not install the motion sensor kit at the following places in order to avoid malfunction.

- (1) Places exposed to direct sunlight
- (2) Places near heat-generating devices
- (3) High humidity places
- (4) Hot surface or cold surface enough to generate condensation
- (5) Places directly exposed to oil mist or steam
- (6) Places affected by the direct airflow of the indoor unit
- (7) Places where the motion sensor may be influenced by fluorescent lamp or sunlight
- (8) Places where the motion sensor may be affected by infrared rays of any other communication devices
- (9) Places where some object may obstruct the motion sensor
- (10) Places where there may be impact on the motion sensor
- (11) Places with strong radio wave or static electricity
- (12) Dusty place where the motion sensor lens may become tainted or be damaged

The detectable area

Unit:mm

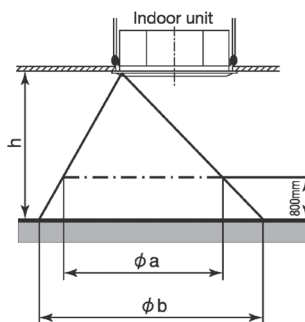



Height of the ceiling h[m]		2.7	3.5	4.0
Detectable area	ϕa [m]	about 4.5	about 6.4	about 7.6
	ϕb [m]	about 6.4	about 8.3	about 9.5

(2) Installation manual

PJF012D504 

 **WARNING**

- Connect the wiring to the PCB in the control box on the indoor unit and fix the wiring securely so as not to apply unexpected stress on the PCB. Loose connection or fixing will cause abnormal heat generation or fire. 
- Make sure the power source is turned off during electrical wiring work. Otherwise, electric shock, malfunction and abnormal operation may occur. 

 **CAUTION**

- Do not install the motion sensor kit at the following places in order to avoid malfunction.

<ul style="list-style-type: none"> (1) Places exposed to direct sunlight (2) Places near heat-generating devices (3) High humidity places (4) Hot surface or cold surface enough to generate condensation (5) Places directly exposed to oil mist or steam (6) Places affected by the direct air flow of the indoor unit (7) Places where the motion sensor may be influenced by fluorescent lamp or sunlight 	<ul style="list-style-type: none"> (8) Places where the motion sensor may be affected by infrared rays of any other communication devices (9) Places where some object may obstruct the motion sensor (10) Places where there may be impact on the motion sensor (11) Places with strong radio wave or static electricity (12) Dusty place where the motion sensor lens may become tainted or be damaged
--	---
- Do not leave the motion sensor without the cover. In case the cover needs to be detached, protect the motion sensor with a packaging or bag in order to keep it away from water and dust. 

Attention

- Instruct the customer how to operate the motion sensor kit correctly by referring to the instruction manual.
- For the installation method of the air-conditioner itself, refer to the installation manual enclosed in the package.

① Accessories

Please make sure that all components are in the package.

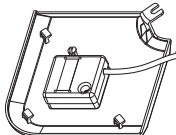
Motion sensor		1
---------------	---	---

② Installing the motion sensor

It is possible to install the motion sensor by replacing the corner lid on the panel.

The detectable area

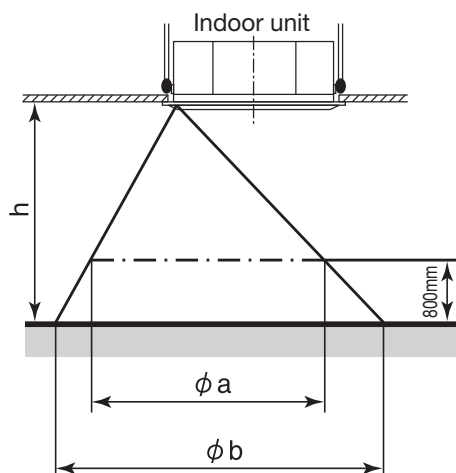

Height of the ceiling	h[m]	2.7	3.5	4.0
Detectable area①	ϕa [m]	about 4.5	about 6.4	about 7.6
Detectable area②	ϕb [m]	about 6.4	about 8.3	about 9.5

Preparation before installation

- ① Remove the inlet grille according to the installation manual of the panel.
- ② Remove the corner lid at the drain pipe side.
- ③ Loosen screws (2 pcs) on the control box of the unit. (It is not necessary to remove the screws.)
- ④ Slide the control lid in the arrow direction, and remove it.

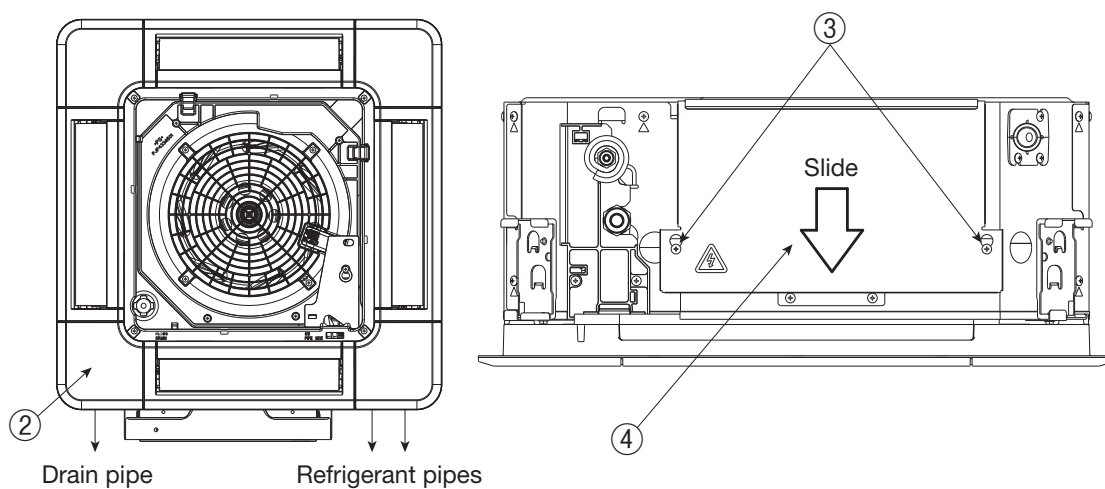

Installation of the motion sensor

- ① Cut the half blanking (4 sections) of the panel as shown in the following figure.
- ② Pass the motion sensor wiring through the opening of the panel.
- ③ Connect the wiring connector to CNL (3P, black) on the PCB in the control box.
- ④ Fix the wiring with a band as shown below.
- ⑤ Install the motion sensor on the panel according to the installation manual of the panel.
- ⑥ Install the control lid with care not to pinch the wiring, and reinstall the control lid with screws (2 pcs.).

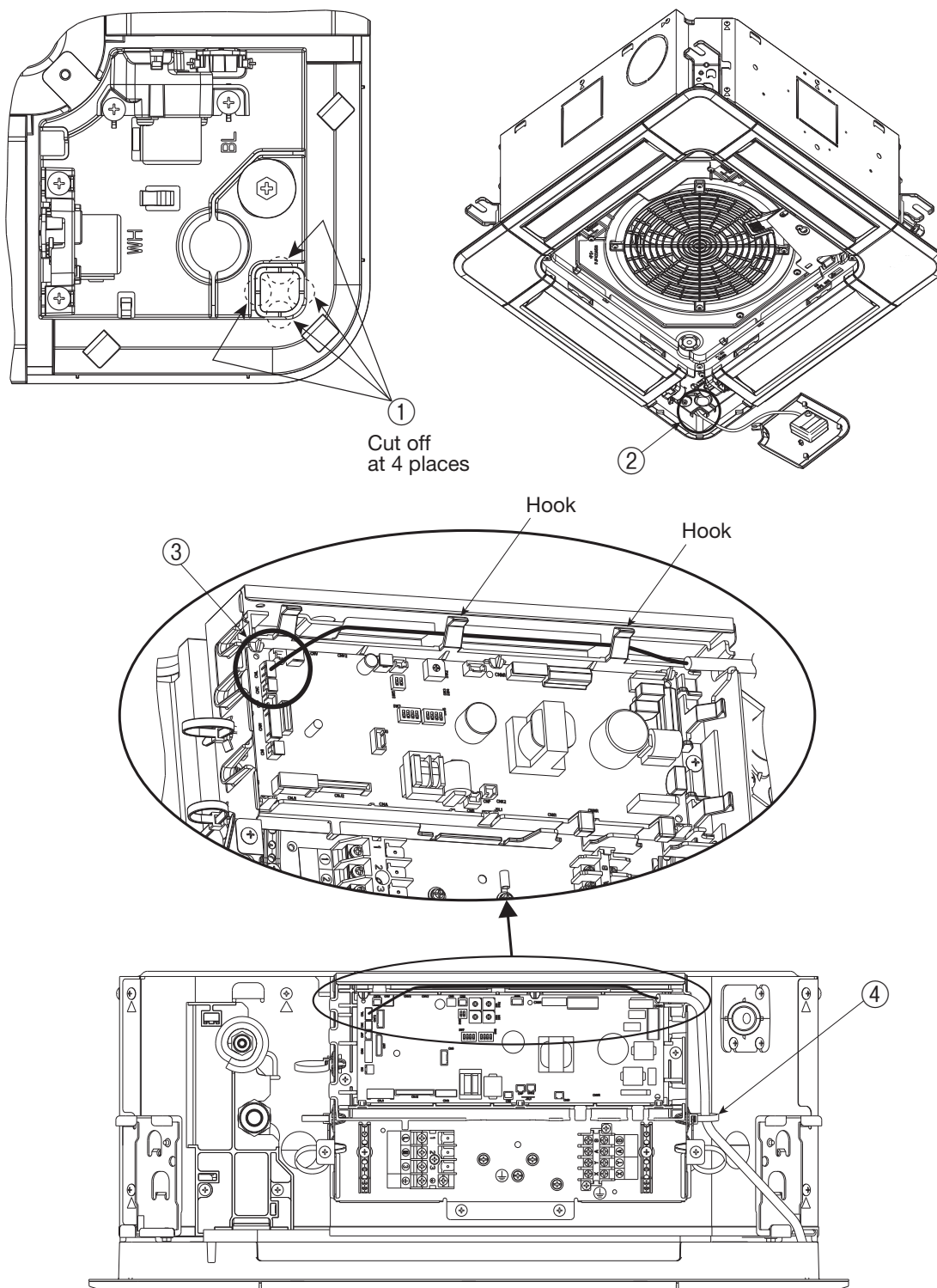

③ Setting the motion sensor

The motion sensor will not function if it is only installed.
Set the function of the motion sensor by the wired or wireless remote control.
Refer to the manual instruction of each remote control for the setting procedure.

Note: It is not possible to set by the following remote control models or older ones.
Wired: RC-EX1A, RC-E5, RCH-E3
Wireless: RCN-E1R

INVERTER PACKAGED AIR-CONDITIONERS

VRF INVERTER MULTI-SYSTEM AIR-CONDITIONERS



MITSUBISHI HEAVY INDUSTRIES THERMAL SYSTEMS, LTD.

2-3, Marunouchi 3-chome, Chiyoda-ku, Tokyo, 100-8332, Japan
<http://www.mhi-mth.co.jp/en/>

Because of our policy of continuous improvement, we reserve the right to make changes in all specifications without notice.

© Copyright MITSUBISHI HEAVY INDUSTRIES THERMAL SYSTEMS, LTD.